

Cast Stone Catalog

LEGENDS
ARCHITECTURAL STONE

281-377-3434

Cast Stone Product Index

<u>Product</u>	<u>Pg</u>	<u>Product</u>	<u>Pg</u>
Accent Blocks -----	1	Headers & Mantels -----	22
Address Blocks-----	2	Keystones -----	26
Address Markers-----	3	Pier Caps – Square -----	27
Balustrades -----	4	Pier Caps – Rectangular -----	33
Balustrades Base and Rail -----	5	Pool Coping -----	36
Balustrade Terminal Posts -----	6	Sign Panels - Square Corner -----	37
Columns Tapered -----	7	Sign Panels - Beveled Edges -----	39
Columns Base & Cap - Tapered --	8	Sign Panels – Designer -----	40
Columns Straight and Rope -----	9	Stars -----	41
Column Base and Caps -----	10	Vent Blocks -----	42
Columns Base & Caps–Pilasters ---	11	Wall Caps -----	43
Commercial- Planter-Bollards -----	12	Water Table -----	46
Corbels -----	13	Windowsills -----	48
Crown Molding & Bracket -----	14	Window Surrounds -----	50
Entry Surrounds -----	15		

CAST STONE ACCENT BLOCKS

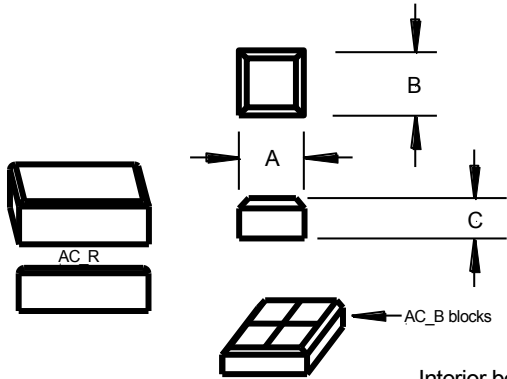

BEVELED ACCENT BLOCKS			
Item Number	'A'	'B'	'C'
AC18	18"	18"	4"
AC12	12"	12"	3.75"
AC9	9"	12"	3.75"
ACR	6.25"	12"	4"
AC8	8"	8"	4"
AC6	6"	6"	3.75"
AC12B	12"	12"	3.75"
AC8B	8"	8"	3.75"

Interior bevels are 1/2" on AC_B items.

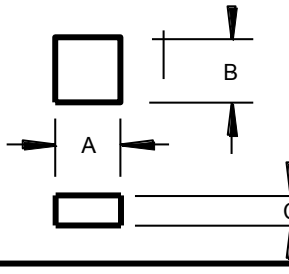

SQUARE ACCENT BLOCKS			
Item Number	'A'	'B'	'C'
AC12S	12"	12"	4"
AC10S	10.5"	12"	5"
AC24S	24"	24"	3.5"
AC30S	30"	30"	3.5"

Recessed Accent Blocks

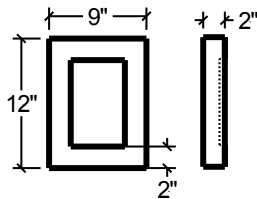

MED 01

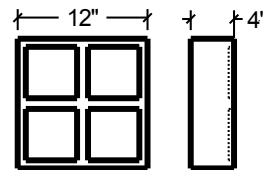

MOL 112906

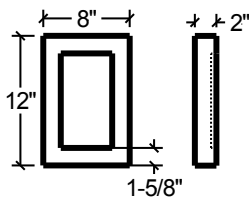

MED 02

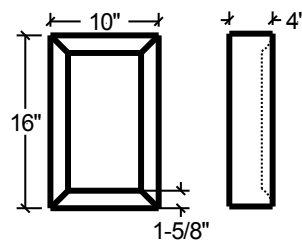

MED 03

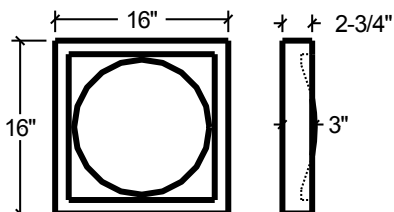

MED 04

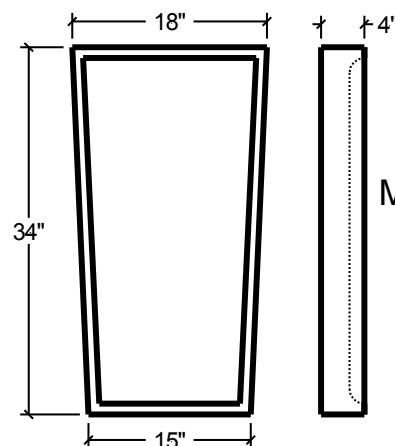

MED 05

CAST STONE ADDRESS BLOCKS

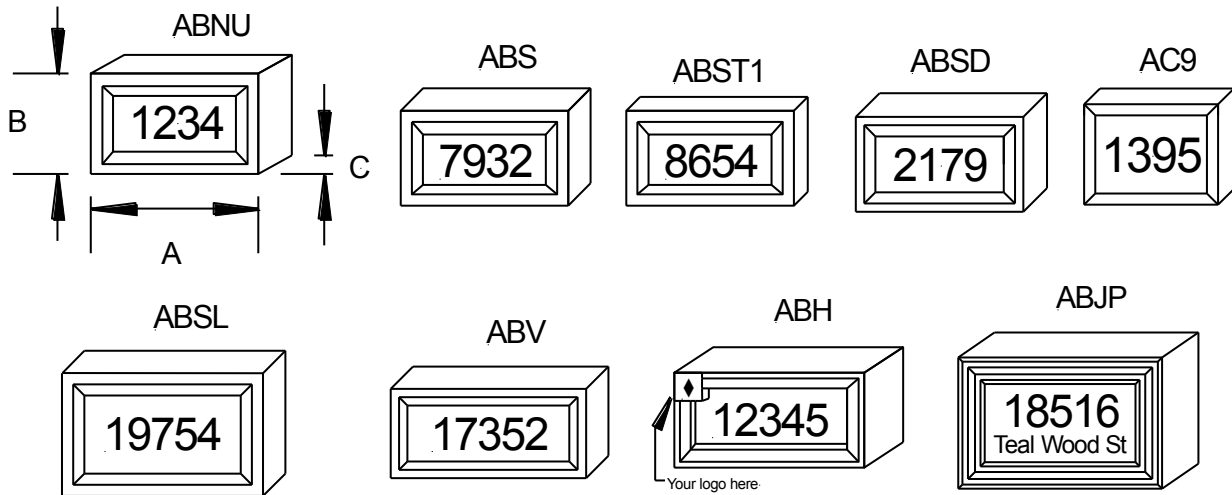

Beveled ADDRESS BLOCKS						
Item Code	'A'	'B'	'C'	Face Size	Number Size	Notes
ABH	17"	8.25"	3.5"	5.31" X 13.81"	3"	Wet pour only
ABJP	18.25"	11.75"	3.75"	6.88" X 13.38"	4"	Dry pack or wet pour
ABNU	14"	9"	3"	5.25" X 10.25"	3"	Dry pack only
ABS	14.5"	8.5"	3"	4.5" X 11"	3"	Dry pack or wet pour
ABSL	18"	11"	3.5"	6.38" X 12.75"	4"	Dry pack or wet pour
ABST1	15"	8.5"	2"	4.5" X 11"	3"	Dry pack or wet pour
ABV	17.5"	8"	3.75"	5.46" X 14.89"	3"	Dry pack only - red river
ABSD	15"	8.5"	3"	5" X 11.5"	4"	Dry pack or wet pour
AC9	12"	9"	2" or 3.5"	7" X 10"	4"	Dry pack or wet pour

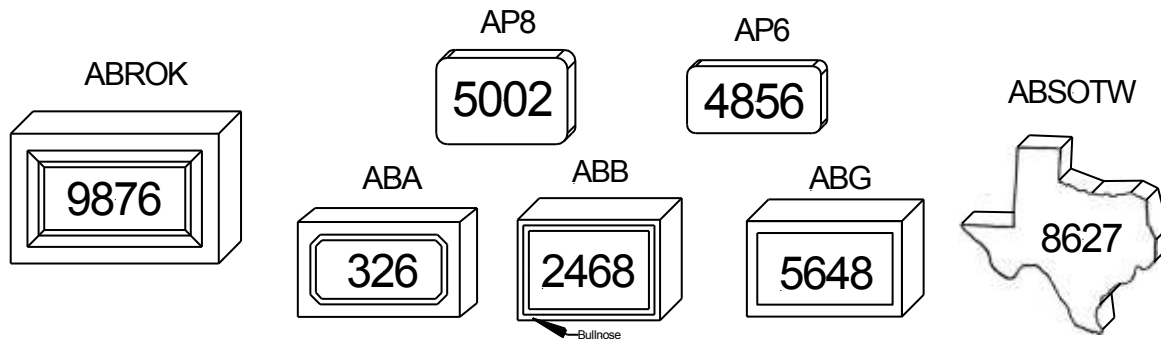

Non-Beveled & Specialty ADDRESS BLOCKS						
Item Code	'A'	'B'	'C'	Face Size	Number Size	Notes
ABG	14"	8.5"	3"	6.11" X 11.88"	4"	Dry pack or wet pour
ABROK	18 5/8"	11 5/8"	3"	6.88" X 13.38"	4"	Dry pack or wet pour
ABA	14.5"	8.5"	3"	5.25" X 11.25"	3"	Dry pack only
ABB	12.75"	9"	3"	7.25" X 10.75"	3"	Dry pack or wet pour
AP8	11.75"	7.75"	1"	11.75" X 7.75"	4"	Wet pour only
AP6	12"	6"	1"	6" X 12"	3"	Wet pour only
ABSOTW	18"	16.5"	1.5"	4" X 13"	3"	Dry pack or wet pour

CAST STONE ADDRESS MARKERS

FSAB-1

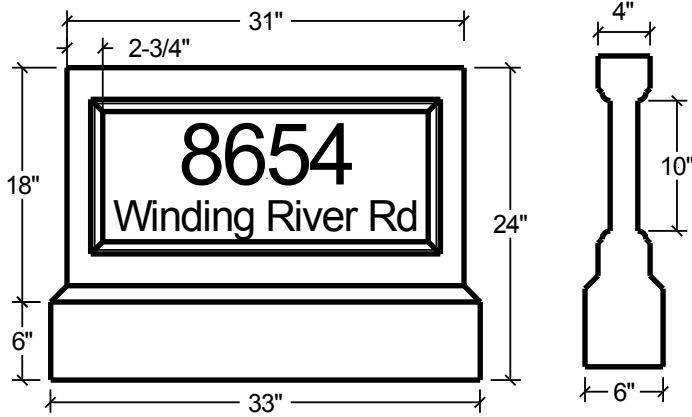

FSAB - 2

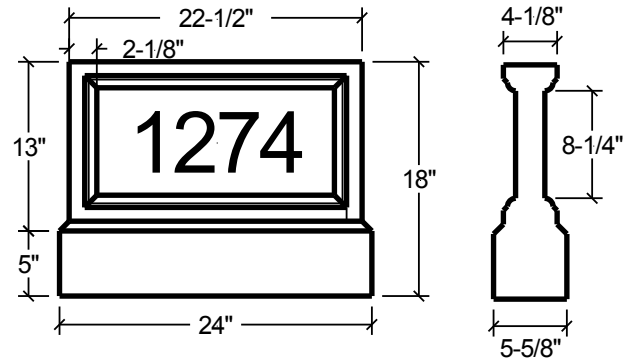

FSAB - 3

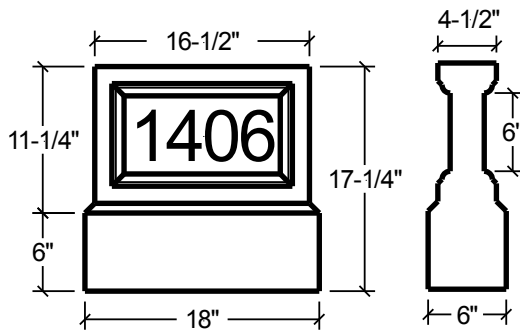

FSAB - 4

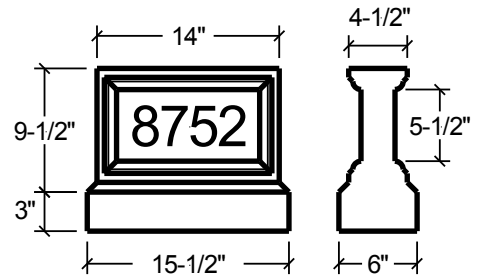

CAST STONE BALUSTRADES

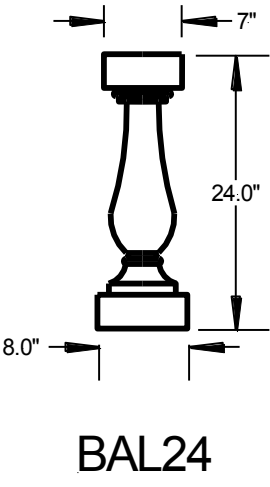
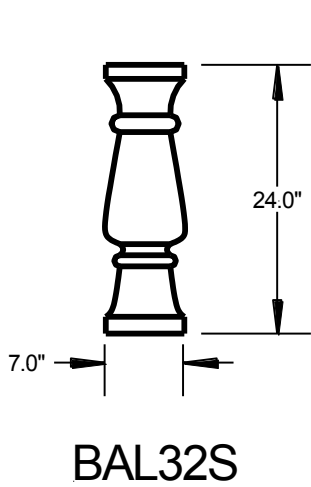
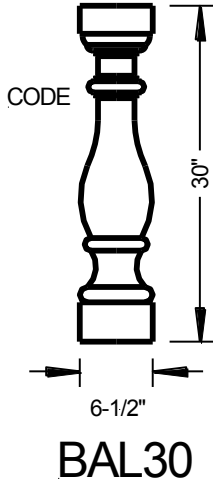
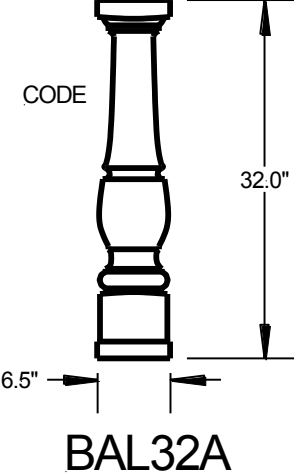
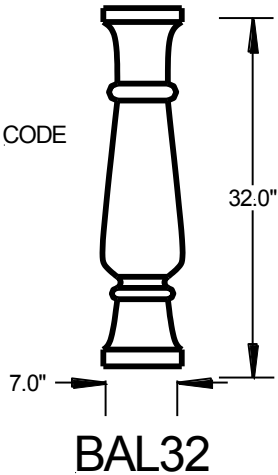

CAST STONE BALUSTRADE BASE AND RAIL

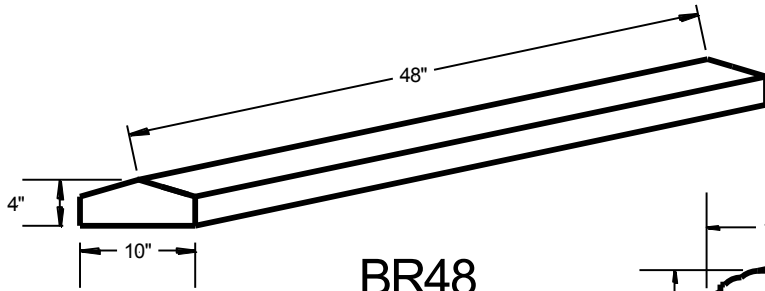

BR48

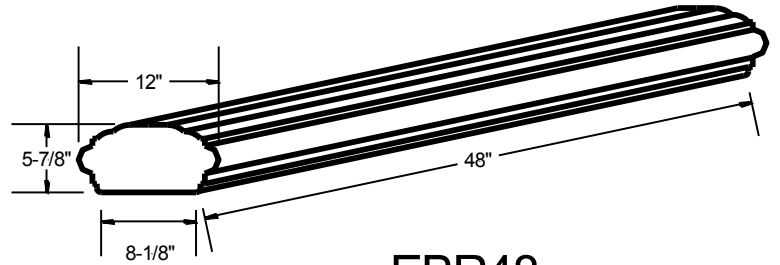

EBR48

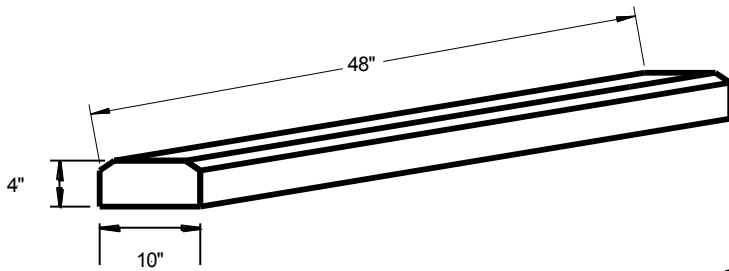

BSB01S

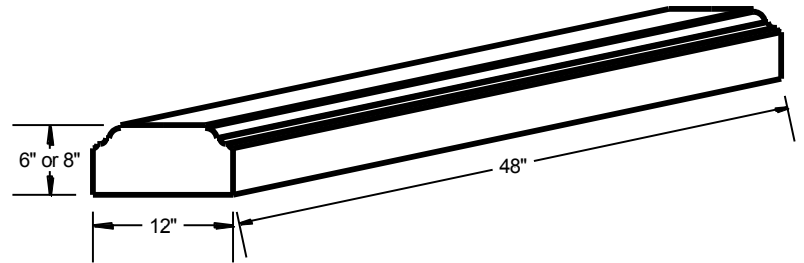

EBB48

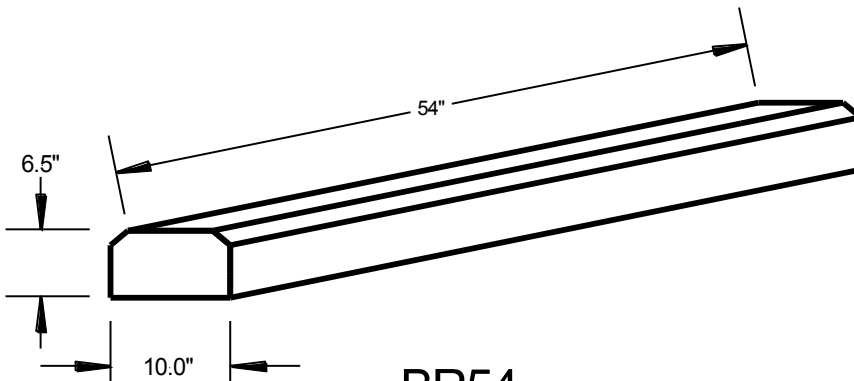

BR54

EBR48 and EBB48 also
available in radius pieces;
203 5/8" Radius
1311 1/4" Radius

BR48, BSB01S and BR54
also available in radius pieces;
4' Radius
7' Radius
12' Radius
19' Radius
39' Radius

CAST STONE BALUSTRADE TERMINAL POSTS

TC

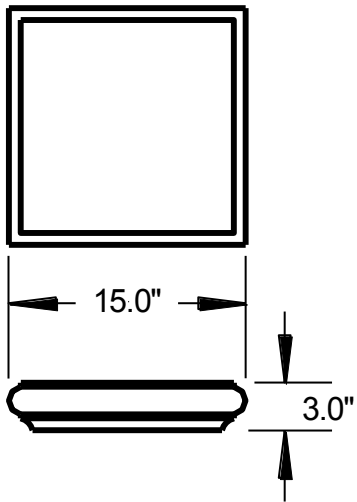

TCN

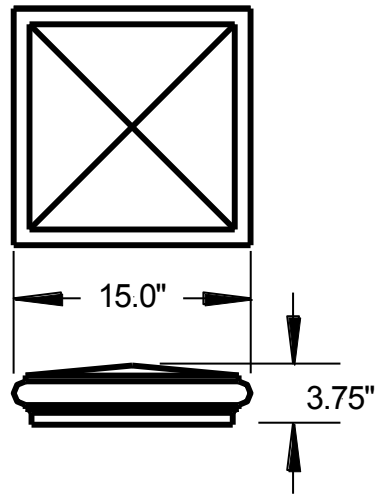

TCN - 14

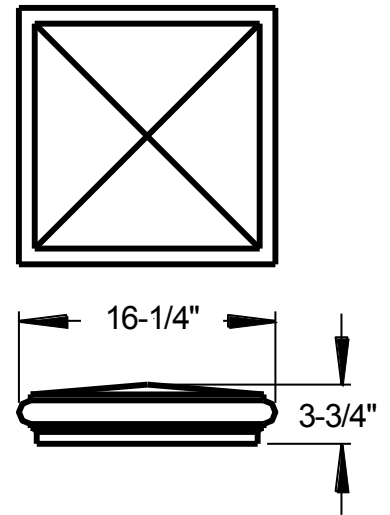

TB

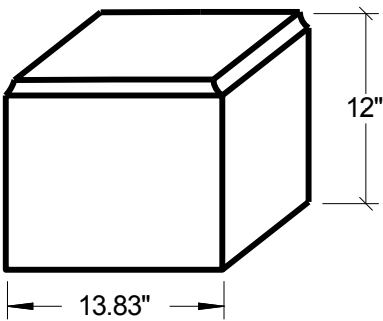

Variable height base
for terminal base

TERM

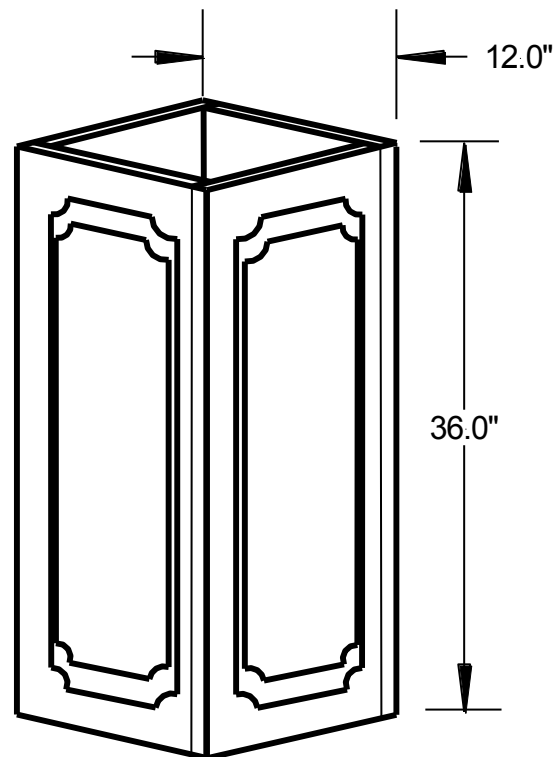

CAST STONE COLUMNS TAPERED

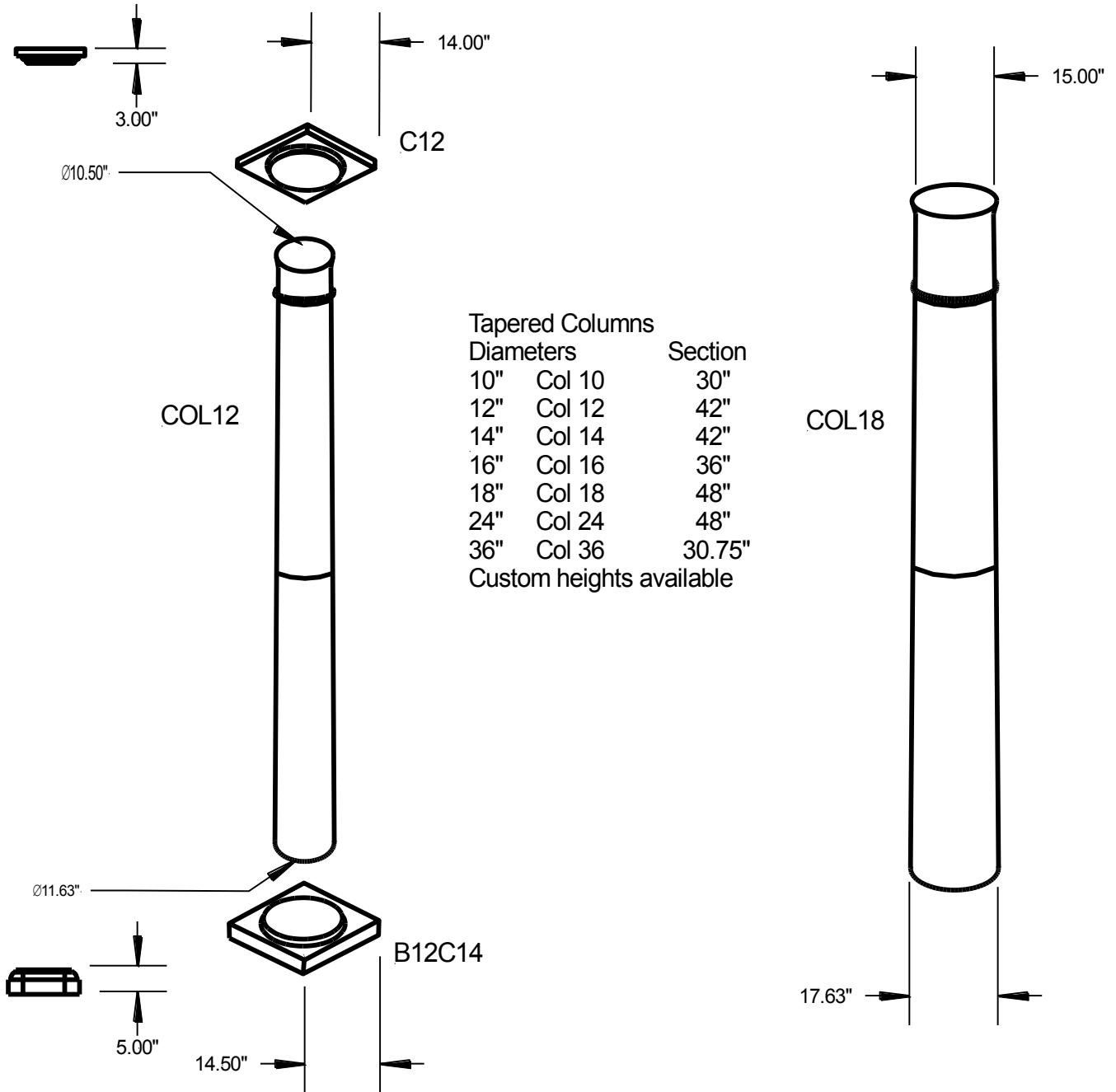

Not Shown: Base for 18" column 24.5"x24.5" with 5.5" height. Stock# B18

CAST STONE COLUMNS BASE & CAP FOR TAPERED COLUMNS

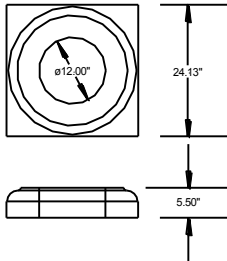
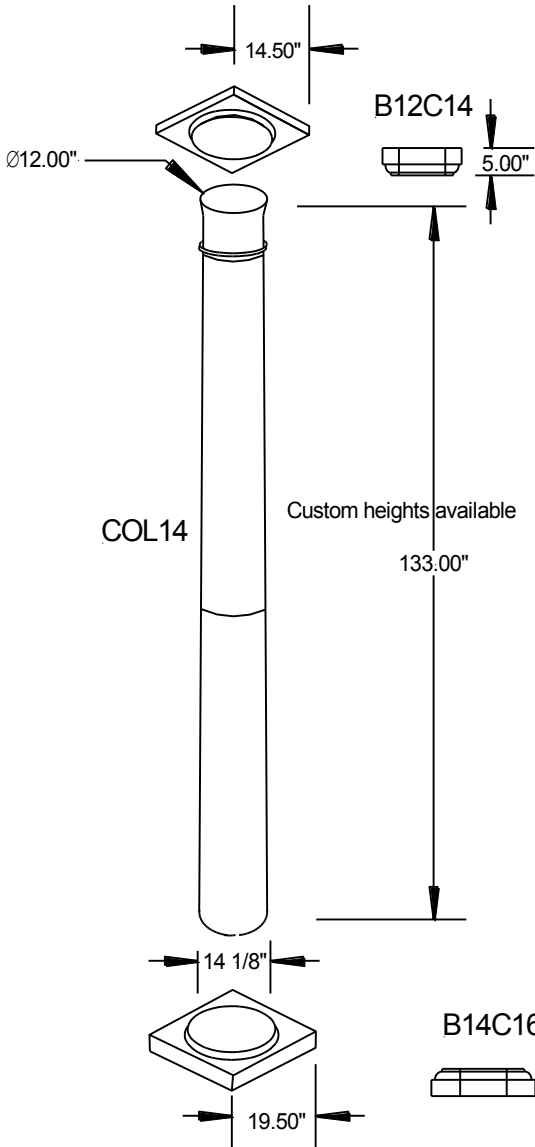

B18
Base for 18" column

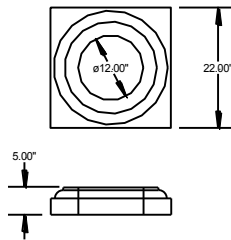

B16C18
Cap for 18" column and
base for 16" column

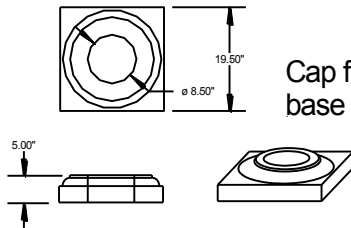

B14C16
Cap for 16" column and
base for 14" column

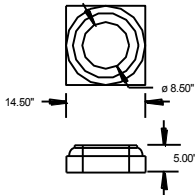

B12C14
Cap for 14" column and
base for 12" column

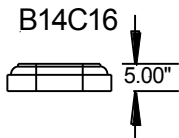

CB - 62408
Base for 12" column

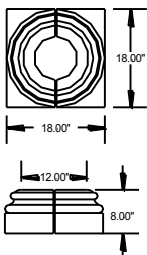

CC - 62008
Cap for 12" column

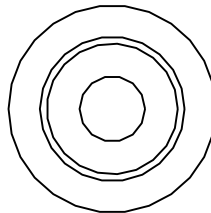
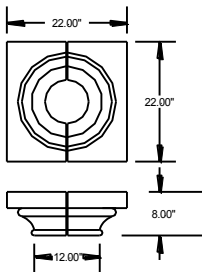

B24
Base for 24" Column

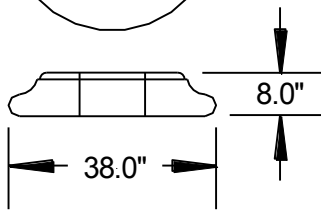

CAST STONE COLUMNS

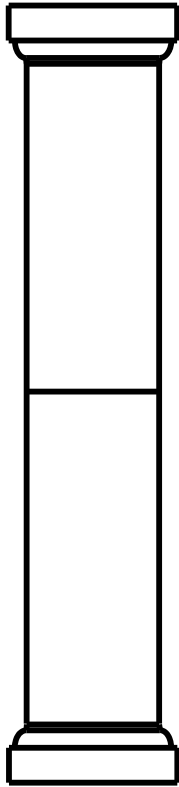

Straight Columns:

Available Diameters

8" Col S8

10" Col S10

12" Col S12

14" Col S14

16" Col S16

18" Col S18

24" Col S24

Standard Sections 48" tall

Col S10 section 42" tall

Custom heights available

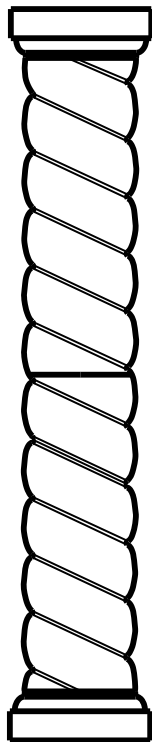

Rope Columns:

10" Diameter - 46" Sections

16" Diameter - 42" Sections

Custom heights available

CAST STONE COLUMN BASE and CAPS

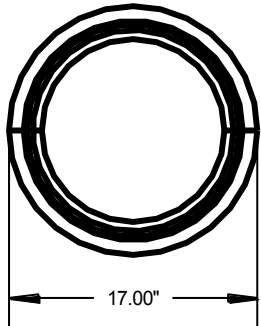

RB12

Round Base and Cap
For 12 " Column
In 2 Pieces

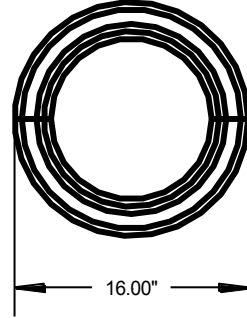

RC12

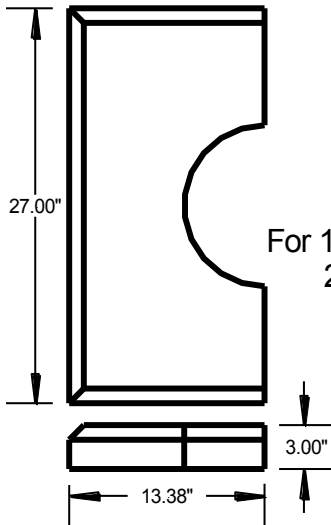

CR18
Riser
For 18 " Column
2 Piece

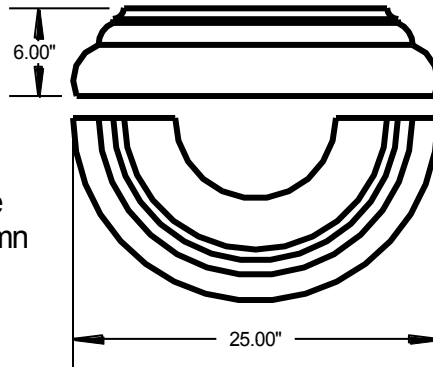

RB18
Round Base
For 18 " Column
In 2 Pieces

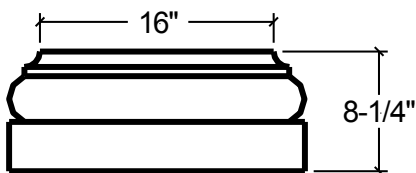

RB16T

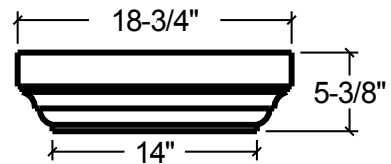

RC16T

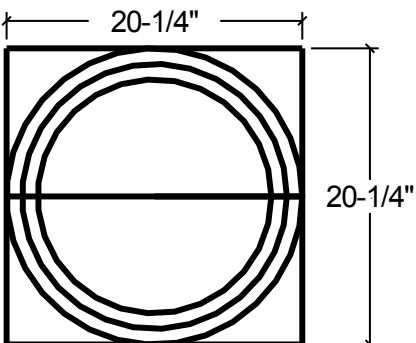

Base and Cap For
16" Tapered Column

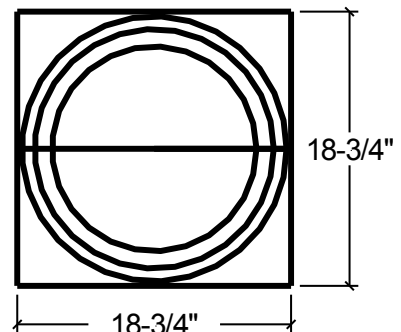

CAST STONE COLUMN BASE and CAPS

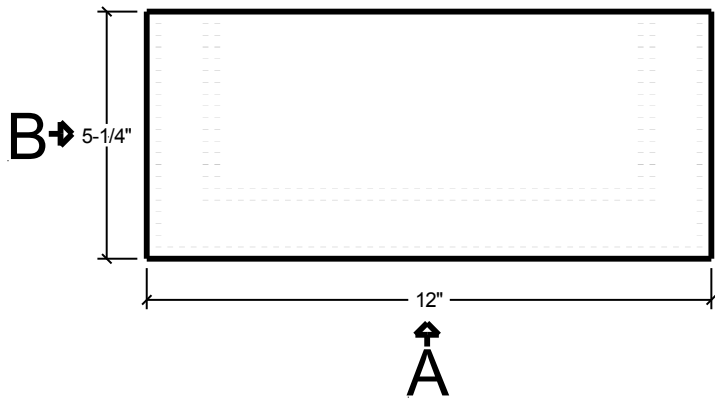

Pilaster Cap
CS9

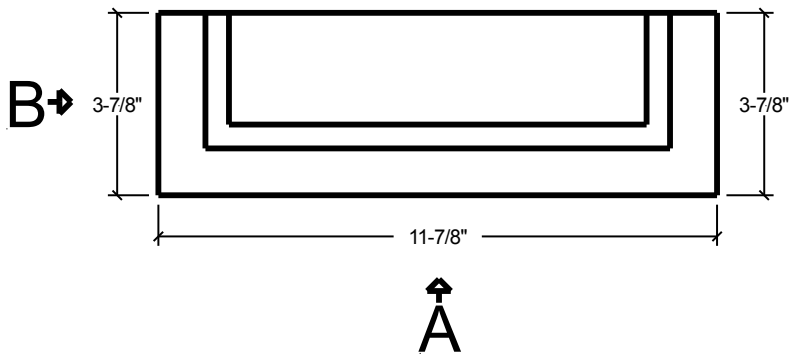
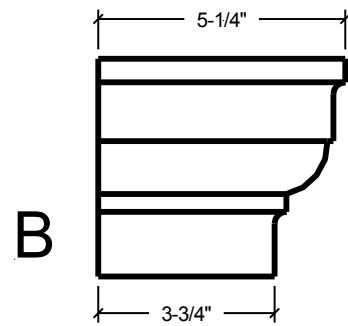
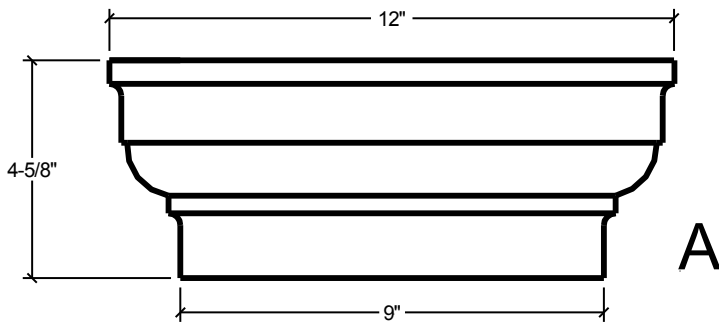

Pilaster Base
BS12

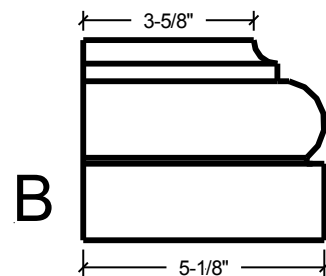
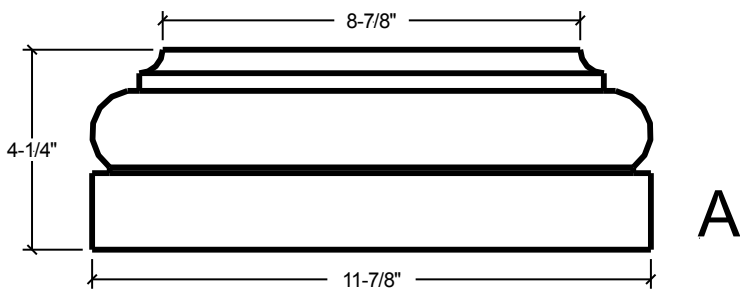

CAST STONE COMMERCIAL PRODUCTS

Planter

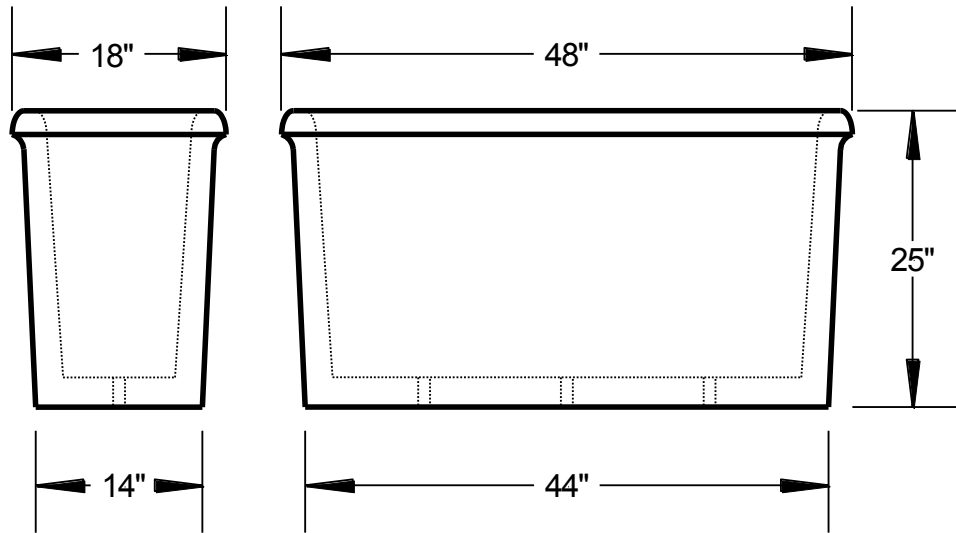

Bollards

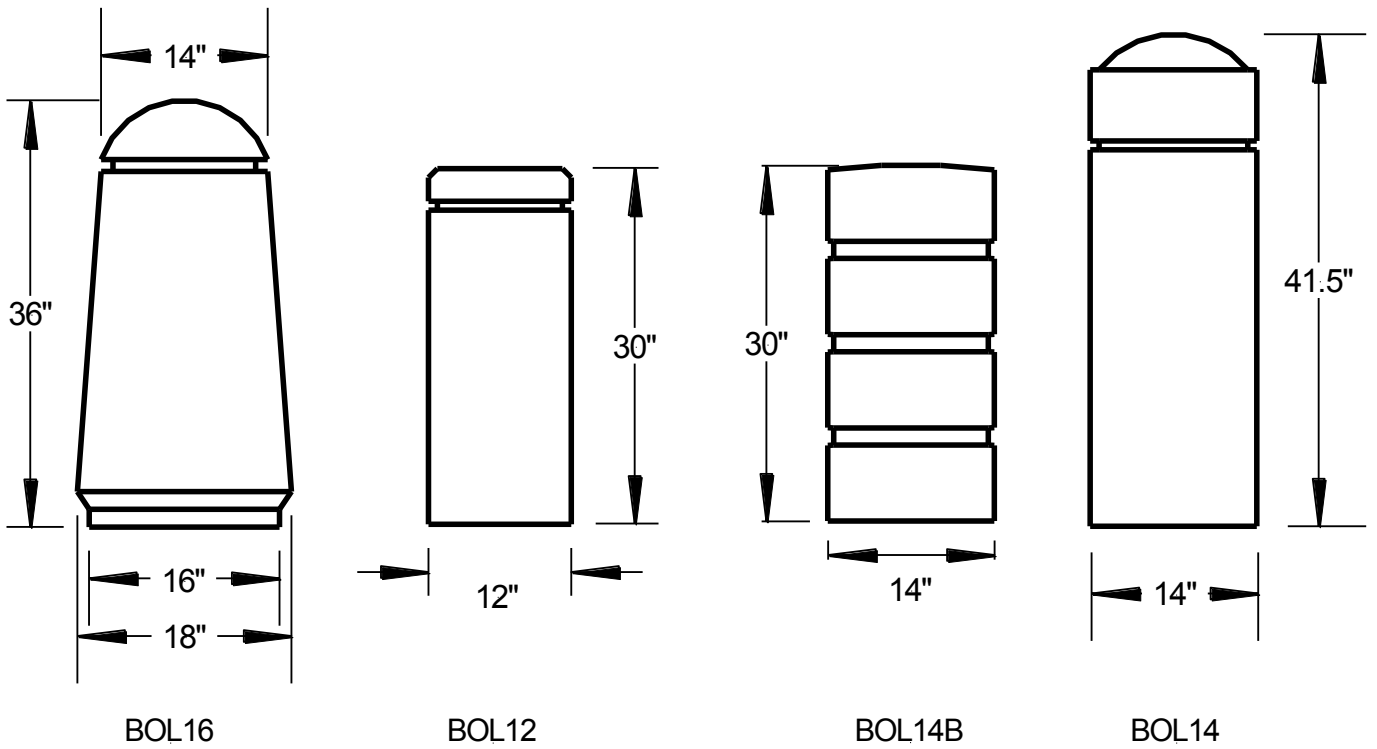

CAST STONE CORBELS

CB1

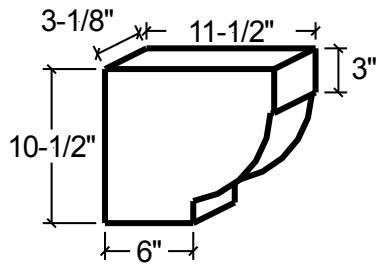

CB2

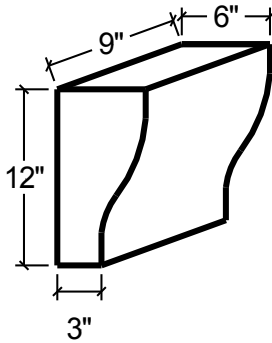

CB3

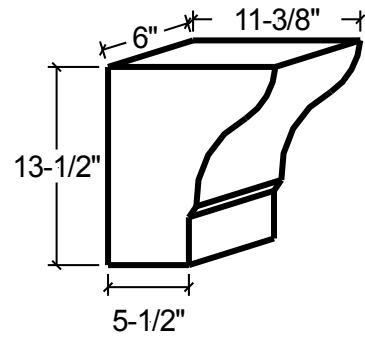

CB4

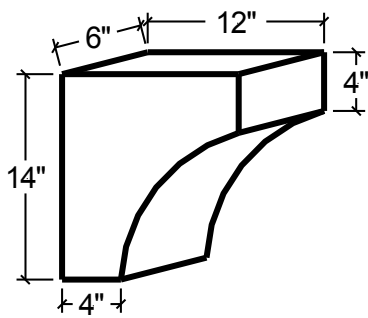

CB5

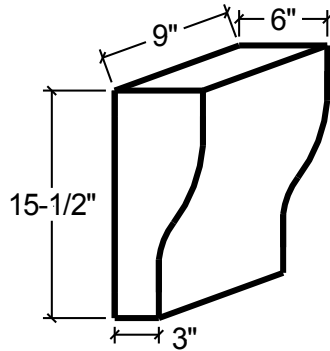

CB6

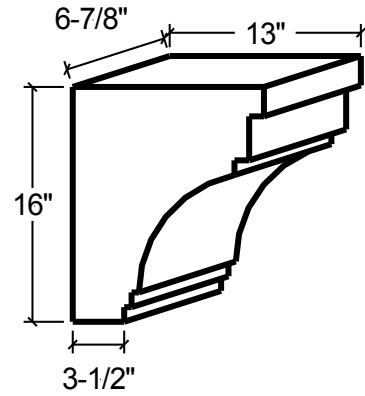

CB7

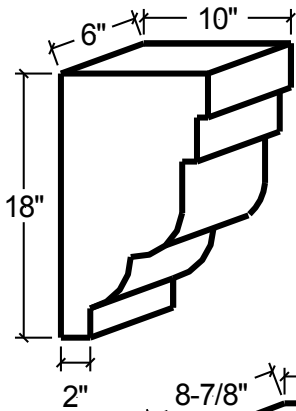

CB9

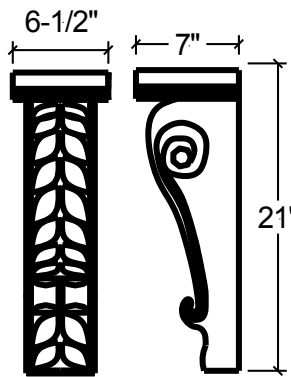

CB10

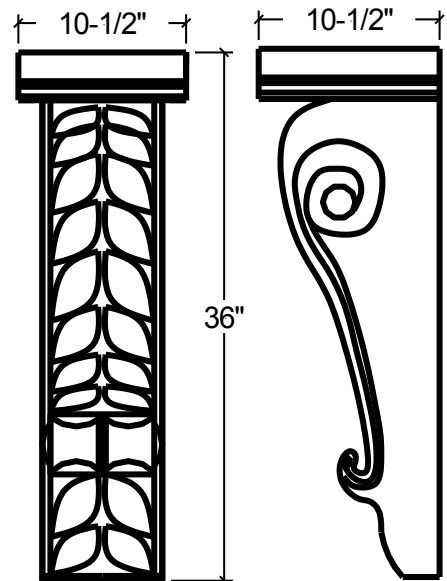

CB8

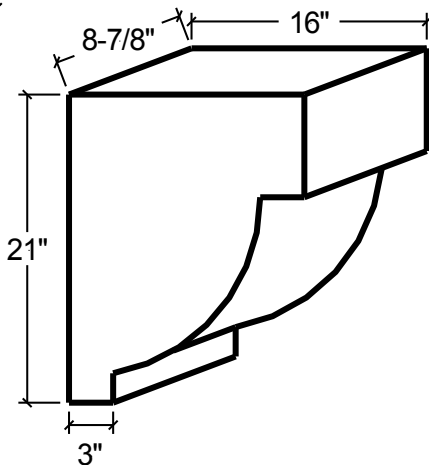

Drawing is approximate

Drawing is approximate

CAST STONE CROWN MOLDING and BRACKET

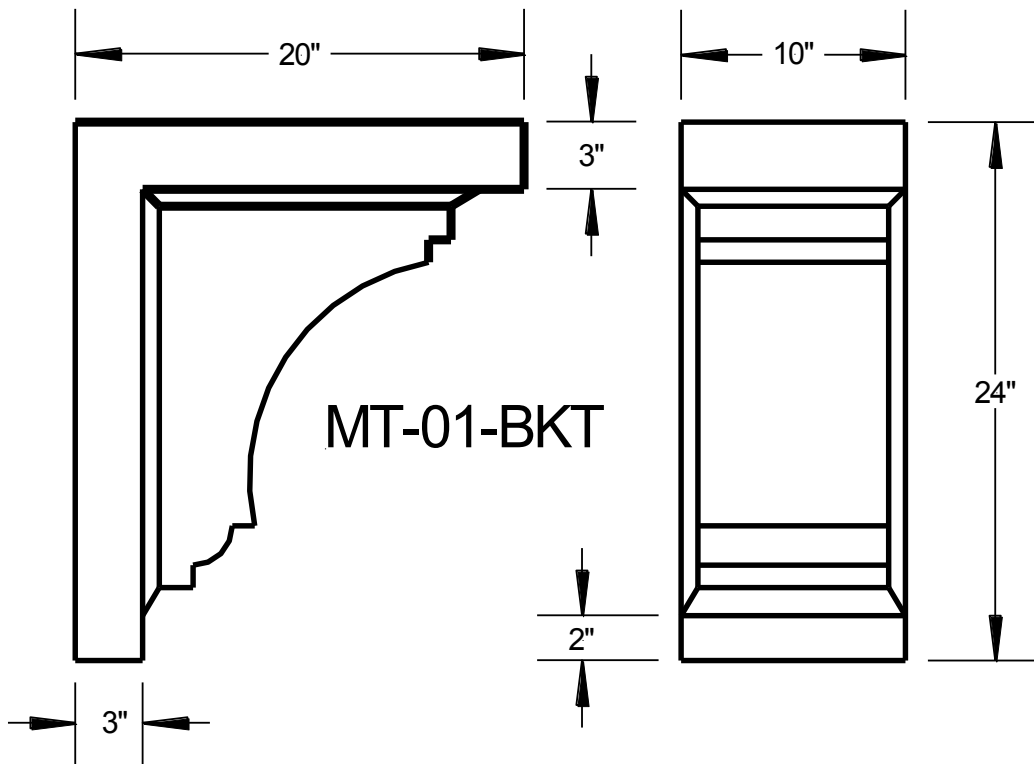
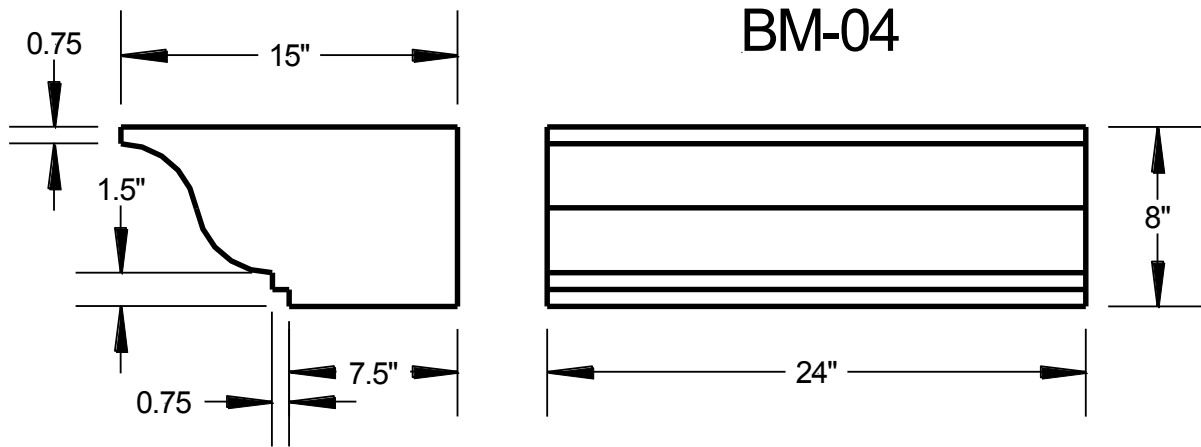

CAST STONE ENTRY SURROUNDS

ES - 01

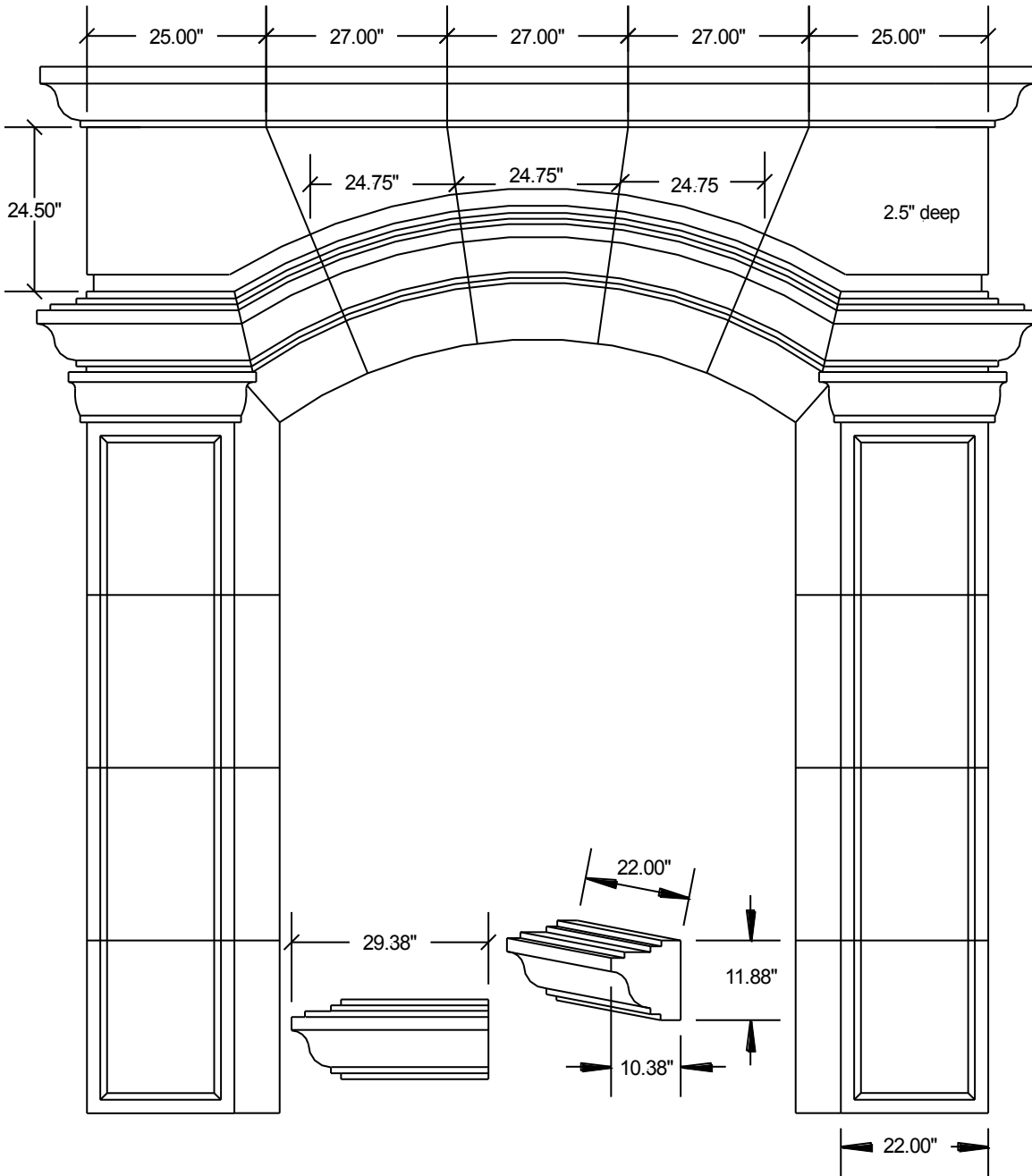

We can custom manufacture different size blocks for your needs.
Call for pricing.

CAST STONE ENTRY SURROUNDS

ES - 02

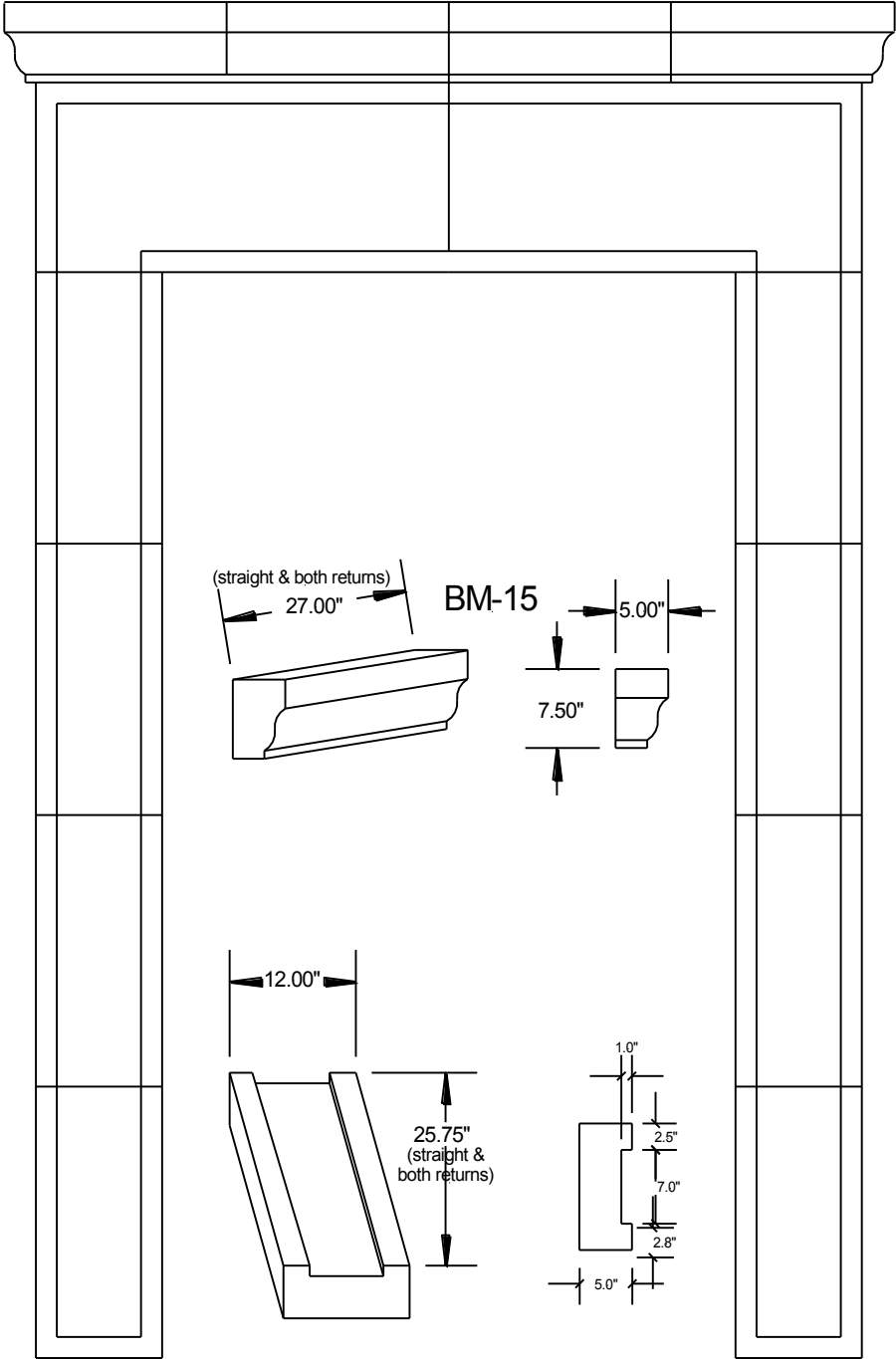

We can custom manufacture different size blocks for your needs. Maximum lengths shown on molds.
Call for pricing.

CAST STONE ENTRY SURROUNDS

ES - 03

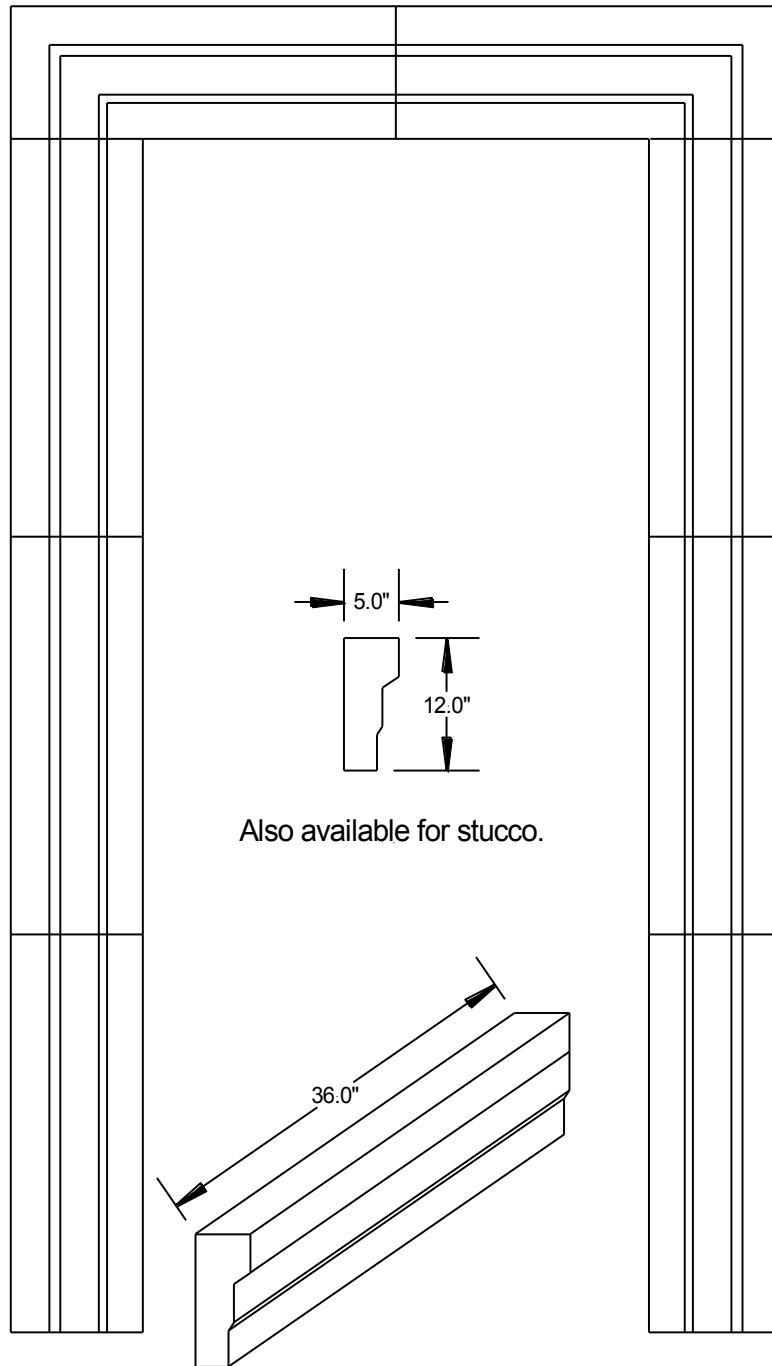

We can custom manufacture different size blocks for your needs.
Call for pricing.

CAST STONE ENTRY SURROUNDS

ES - 04

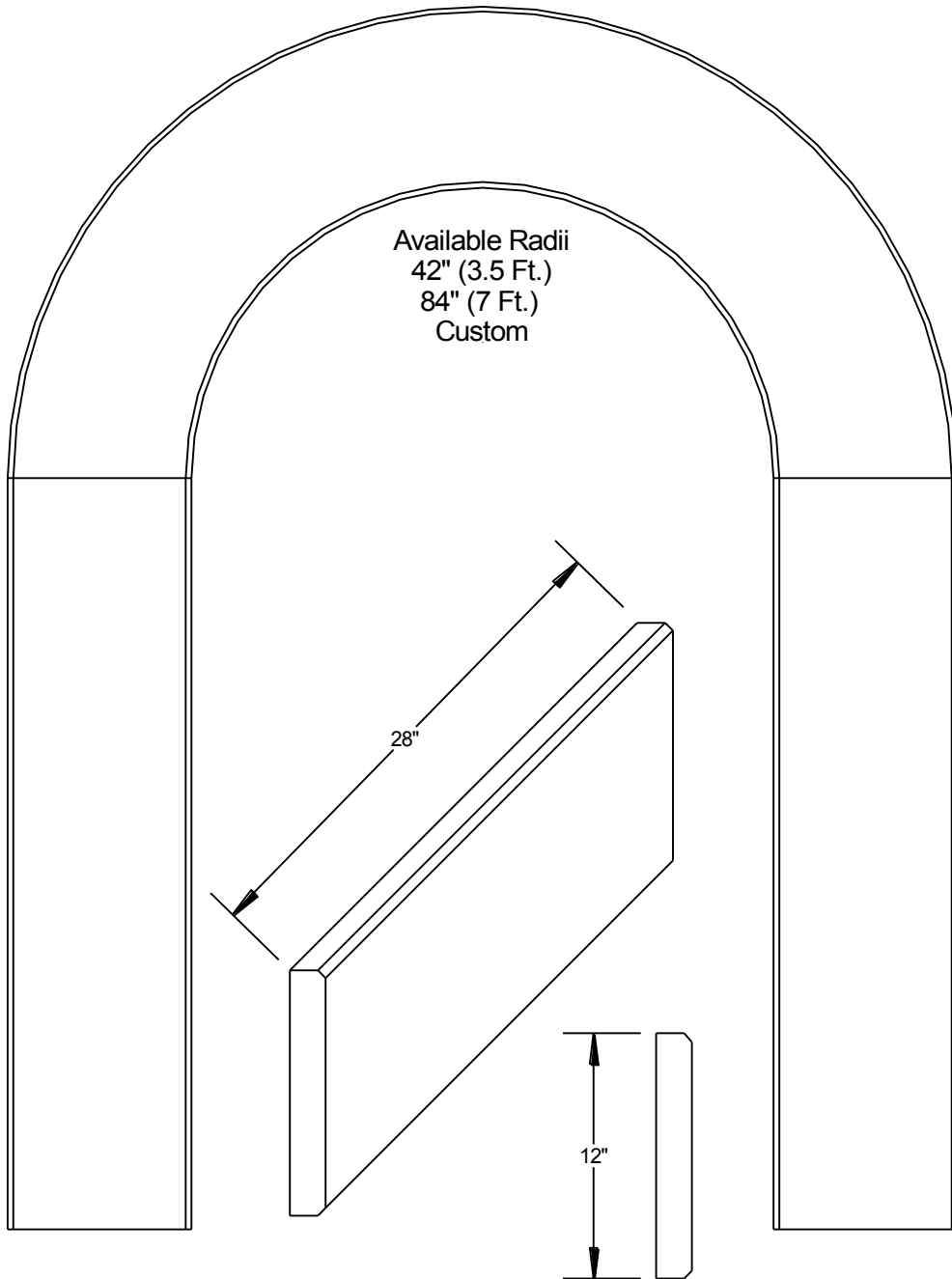

We can custom manufacture different size blocks for your needs.
Call for pricing.

CAST STONE ENTRY SURROUNDS

ES-05

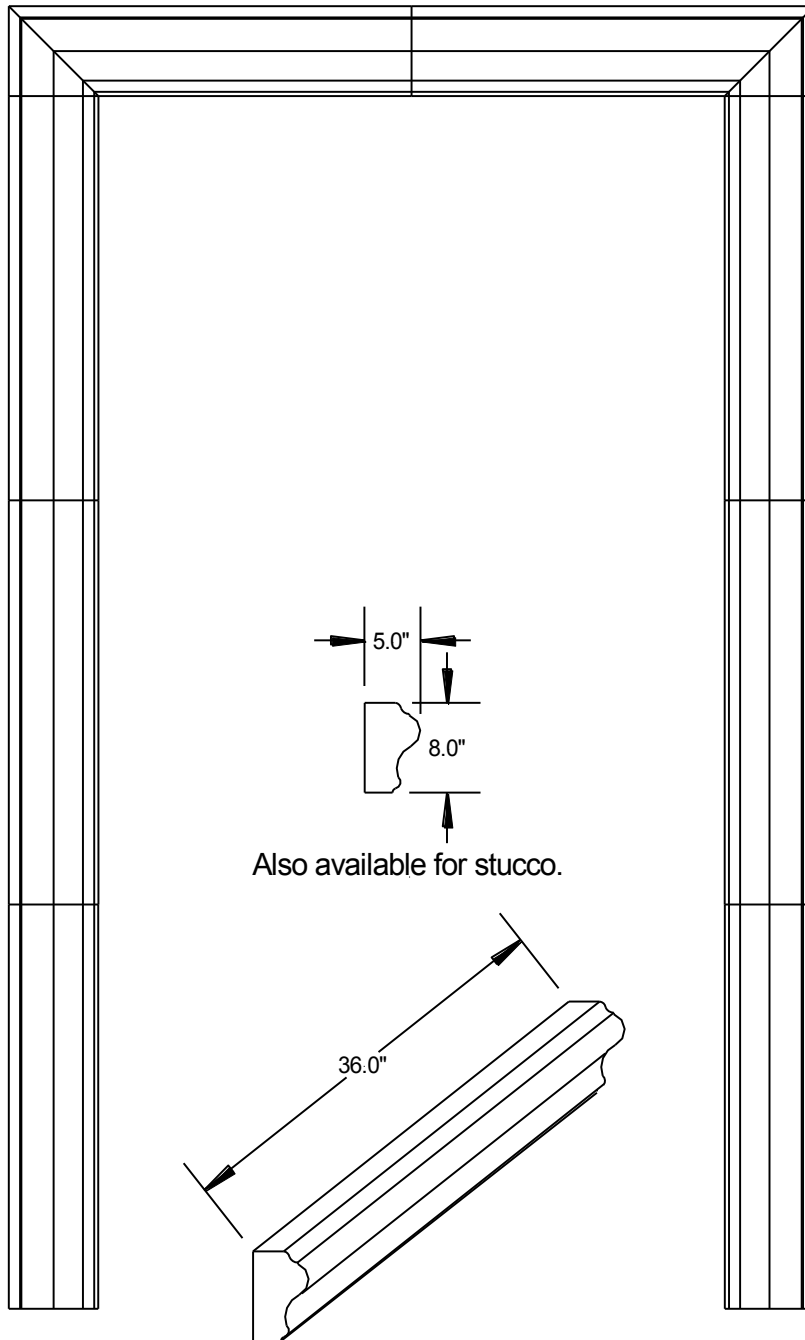

We can custom manufacture different size blocks for your needs.
Call for pricing.

CAST STONE ENTRY SURROUNDS

ES - 06

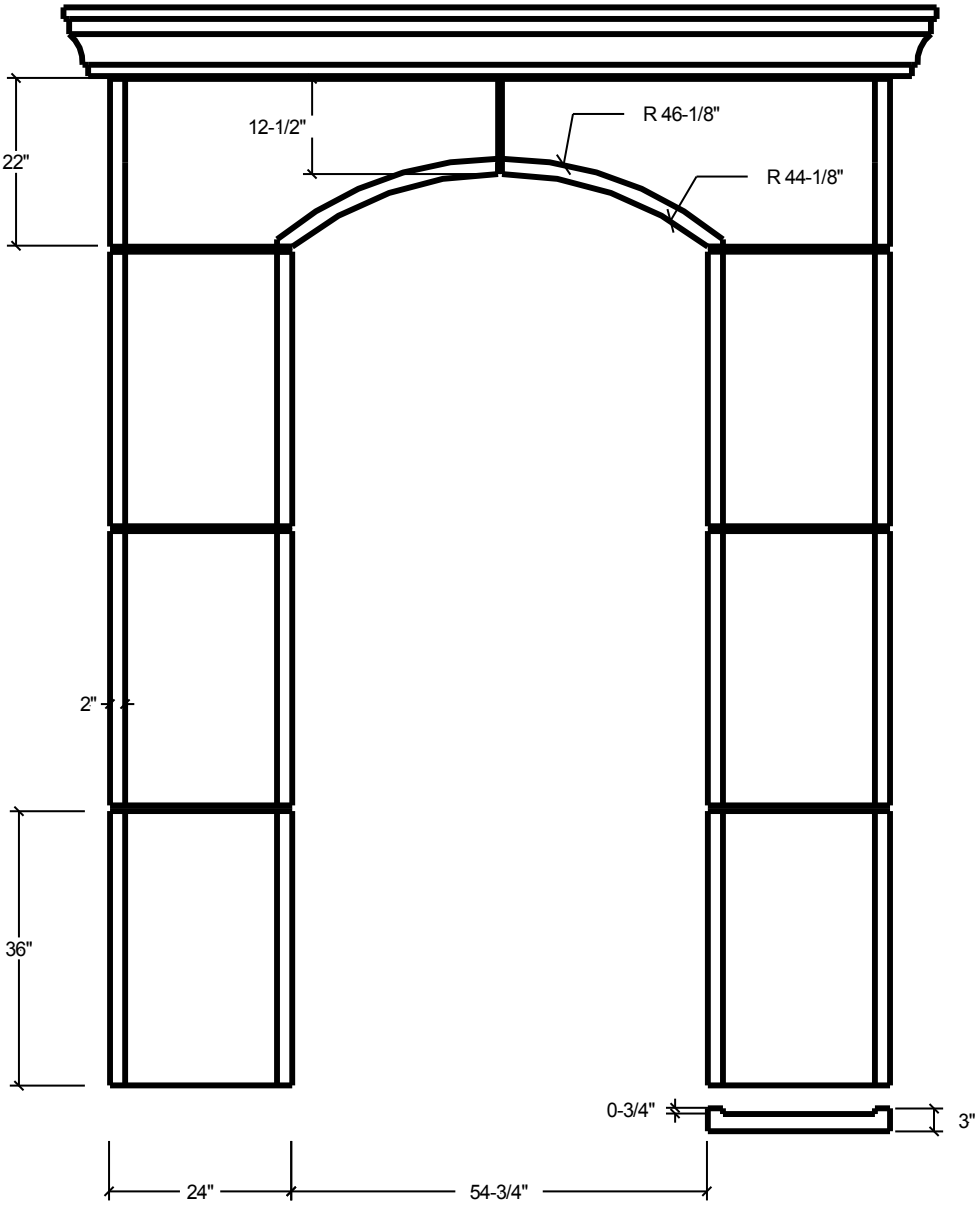

We can custom manufacture different size blocks for your needs.
Call for pricing.

CAST STONE ENTRY SURROUNDS

ES - 07

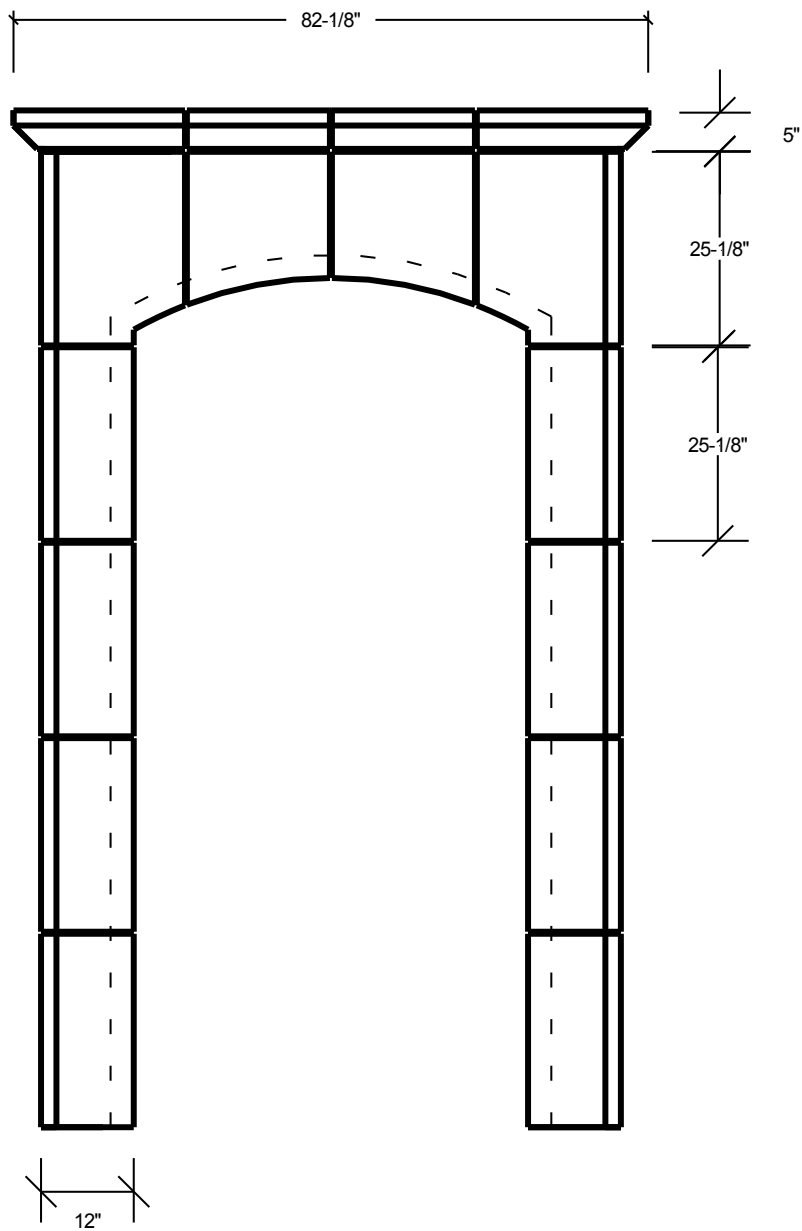

We can custom manufacture different size blocks for your needs.
Call for pricing.

CAST STONE HEADERS & MANTELS

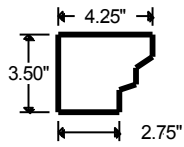

BM - 07

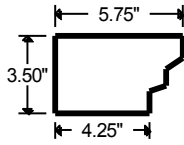

BM - 07 A

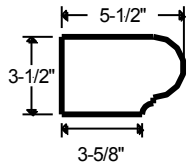

DNLG - 1

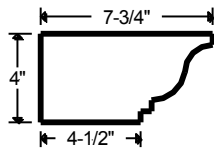

BM - 02

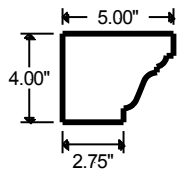

BM - 08

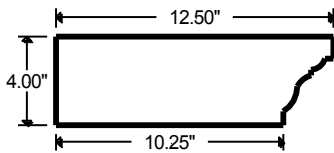

BM - 09

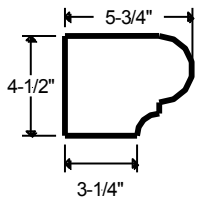

DNLG - 2

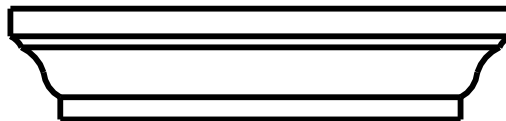
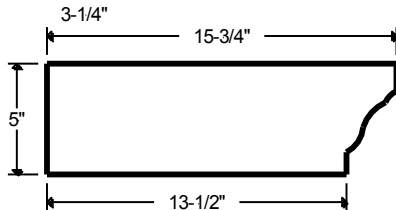

BM - 21

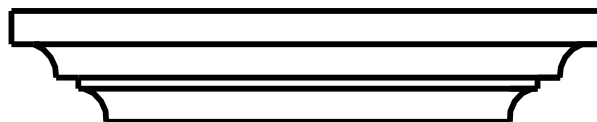
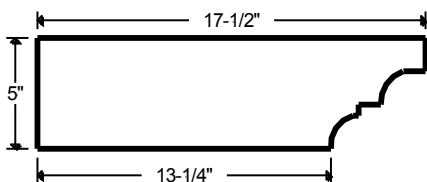

BM - 20

CAST STONE HEADERS & MANTELS

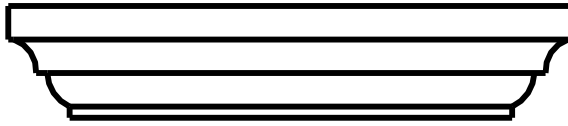
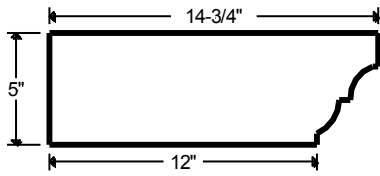

BM - 23

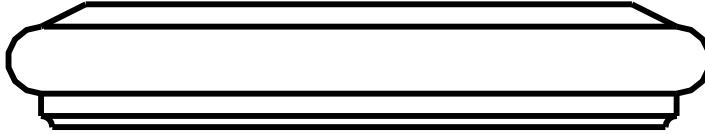
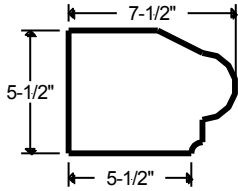

DNLG - 3

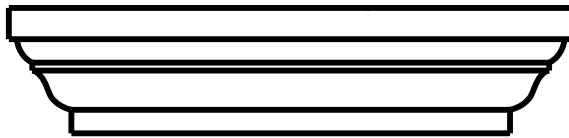
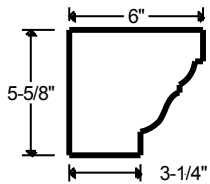

BM Tapia

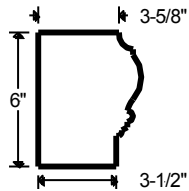

DLNG - 4

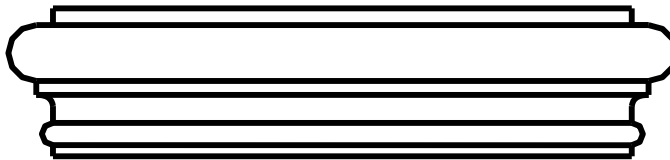
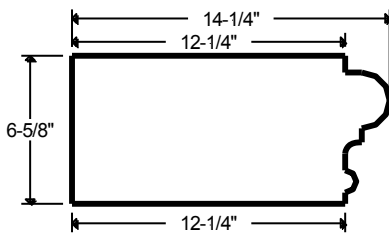

BM-27

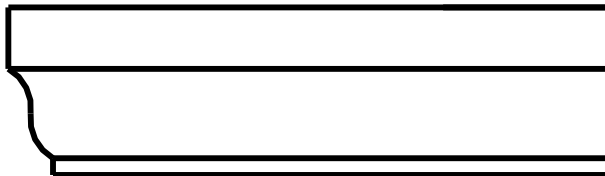
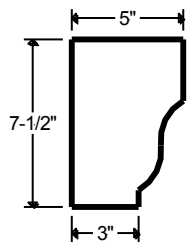

BM - 15

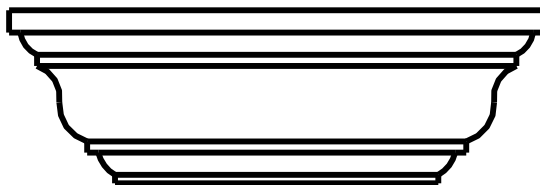
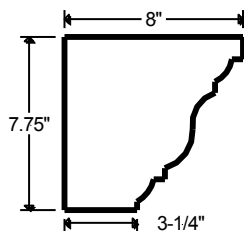

BM - 19

CAST STONE HEADERS & MANTELS

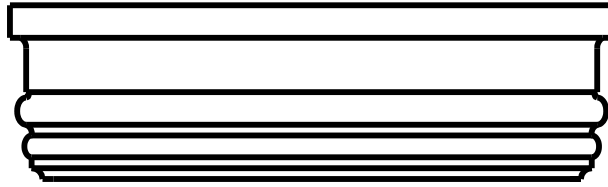
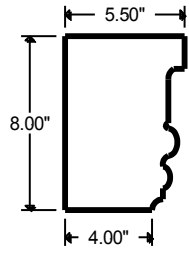

BM - 26

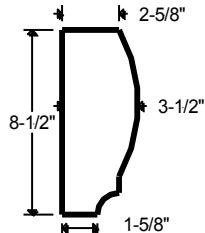

BM - 22

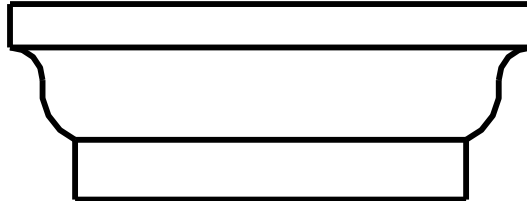
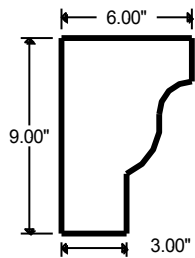

BM - 13

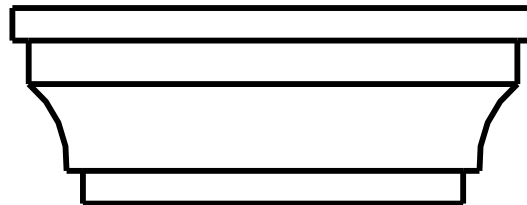
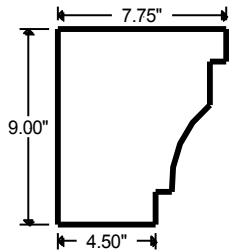

BM - 14

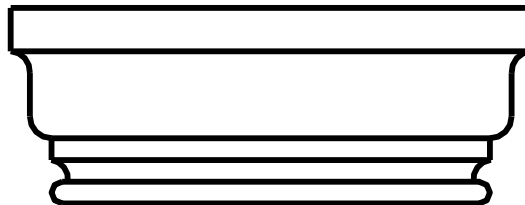
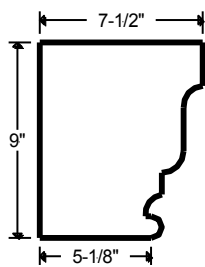

BM - 16

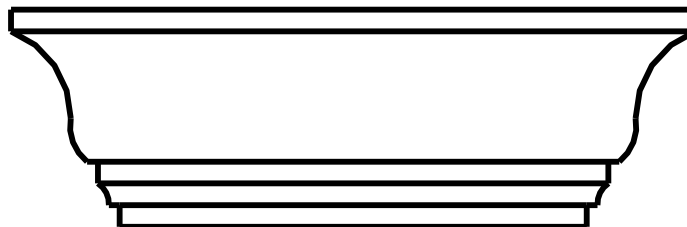
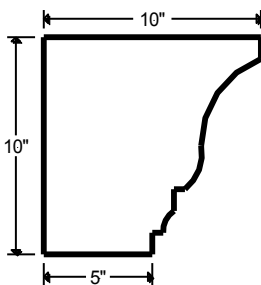

BM-28

CAST STONE HEADERS & MANTELS

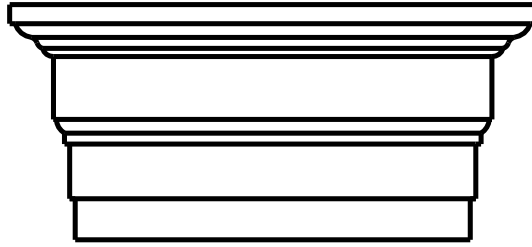
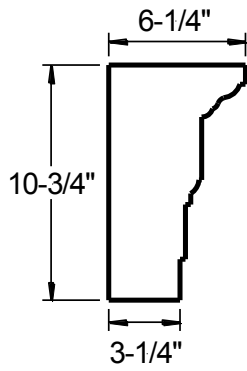

MO - 01

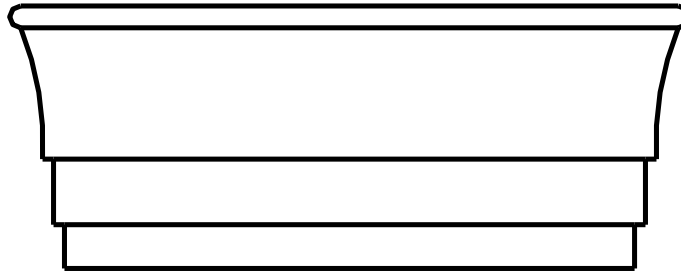
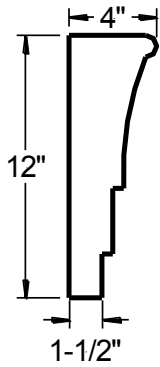

ZM-01
R&L Returns
Length 36"

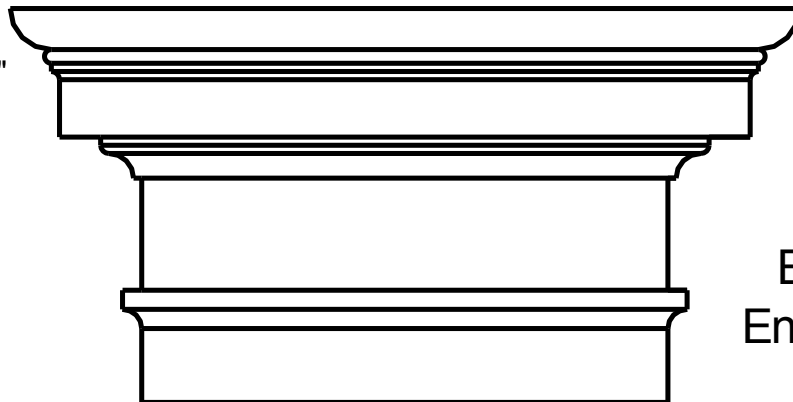
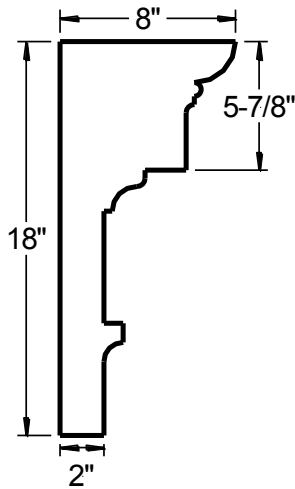

BM - 17
Entablature

CAST STONE KEYSTONES

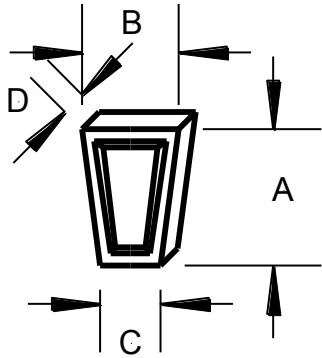

RECESSED KEYSTONES				
Item Number	'A'	'B'	'C'	'D'
KSR9	9"	8"	4.5"	3"
KSR12	11.25"	8"	5"	3"

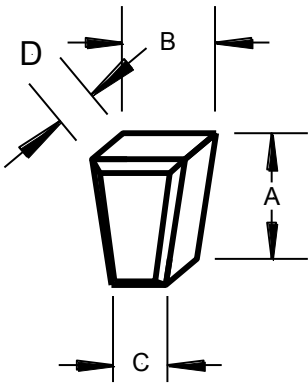

BEVELED KEYSTONES				
Item Number	'A'	'B'	'C'	'D'
KS16	16.0"	11.0"	5.5"	3.5"
KS14	14.0"	10.5"	5.5"	3.5"
KS12	12.0"	8.5"	5.0"	3.5"
KS9	9.0"	7.75"	4.5"	3.5"
KS6	6.0"	4.88"	3.0"	3.5"
KSA	11.63"	9.0"	7.0"	2.0"
KSB	19.63"	12.0"	9.0"	2.0"
KSC	15.63"	10.5"	8.0"	2.0"
KS5	5"	3.5"	2"	3.5"

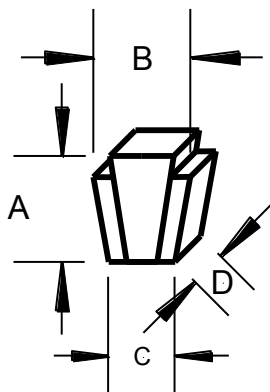

BATWING KEYSTONES				
Item Number	'A'	'B'	'C'	'D'
KSS	14"	10"	6"	4"
KSB12	11.5"	9"	6"	4"
KSB9	8.75"	8"	3.5"	3.5"

CAST STONE PIER CAPS

PC - 10D

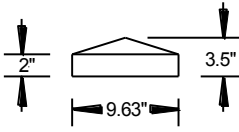

PC - 64

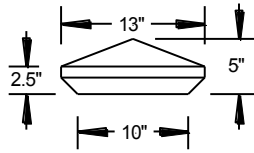

TC

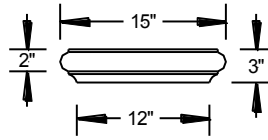

TCN

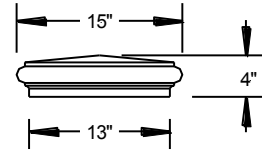

PC - 26

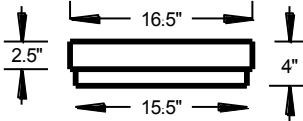

PC - 16

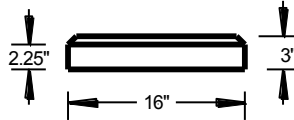

PC - 24

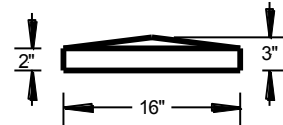

DPC - 16

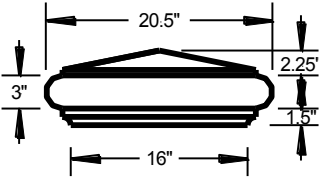

PC - 22

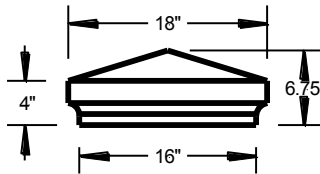

PCD

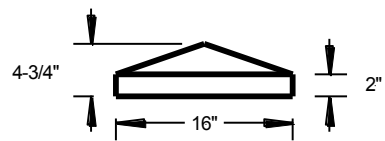

PC - 44

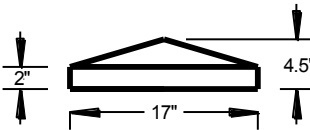

PC - 17-1

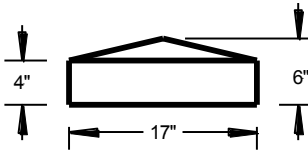

DPC - 16A

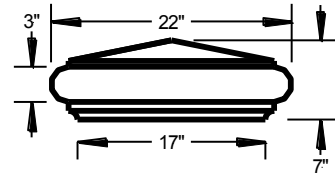

PC - 18D

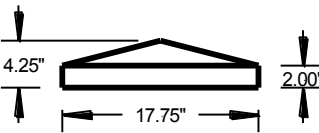

PC - 18

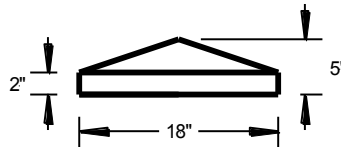

AWPC

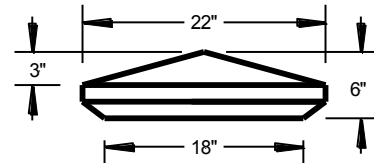

All of our pier caps can be manufactured with holes or flat spots.
Call for pricing

CAST STONE PIER CAPS

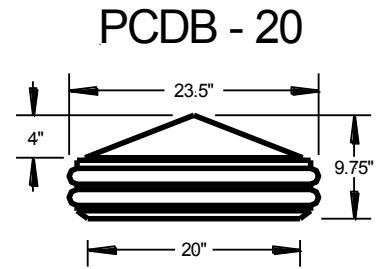
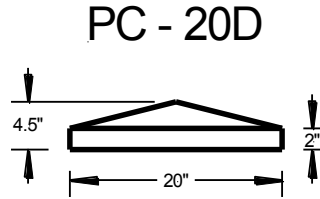
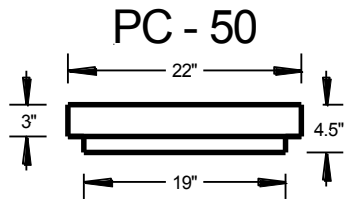

PC - 01

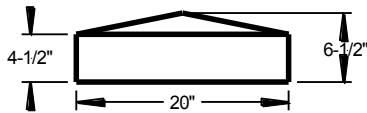

PCSB - 20

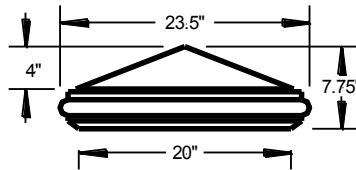

BB - 100D*

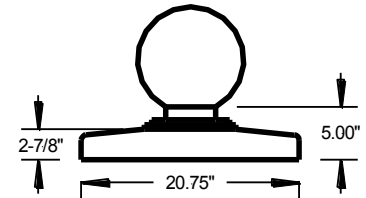

∅ = 8", 10", 12", 18"

*Connecting neck varies slightly from ball size to ball size. Balls can be installed on flat caps as well as pyramid caps.

PC - 57

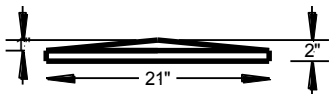

PCF - 21

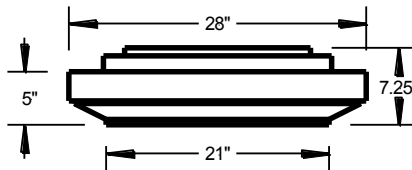

PC - 54A

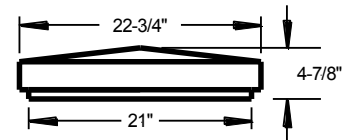

PC - 28

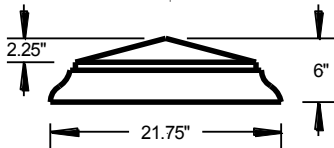

PCT - 22

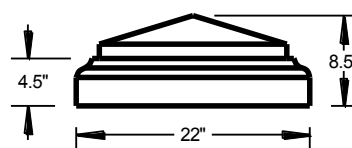

PC - 22D

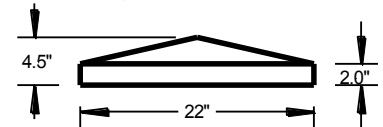

AWPC - 04

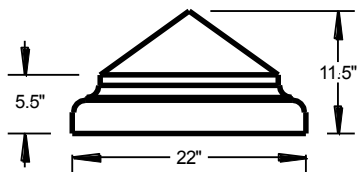

PC - 12

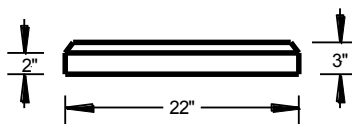

PC - 46

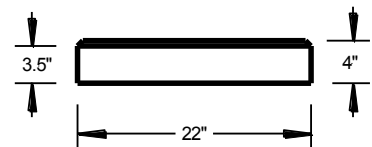

All of our pier caps can be manufactured with holes or flat spots.
Call for pricing

CAST STONE PIER CAPS

PC - 29

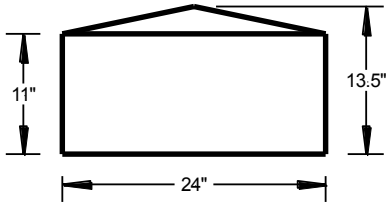

AW - 24

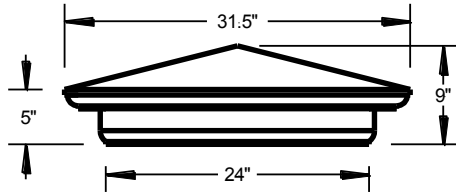

PC - BUL24

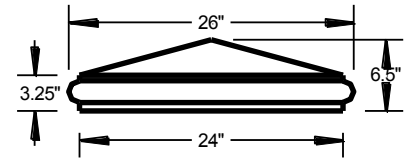

PC - 54

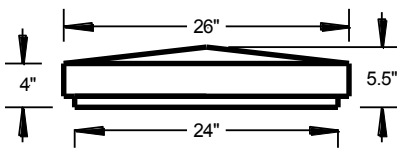

PC - 13

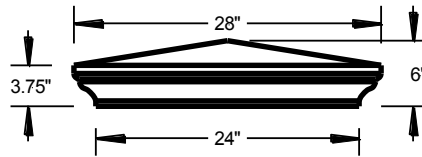

PC - 24D

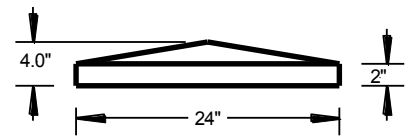

DPC - 25

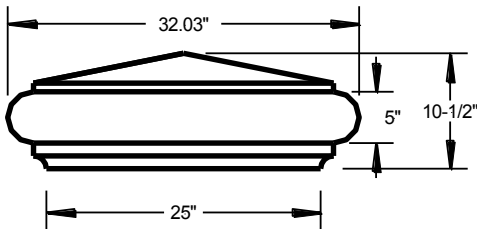

PCF - 21A

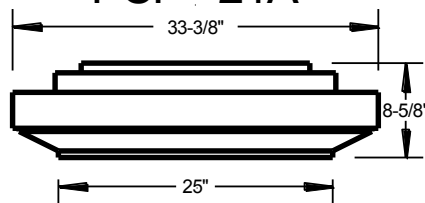

PC - 27

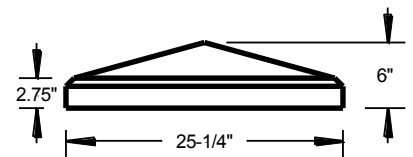

PC - 30

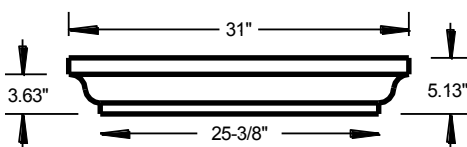

AW - 26

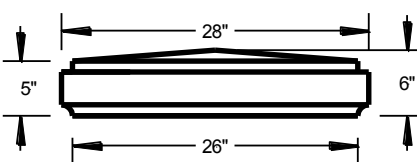

PC - B26D

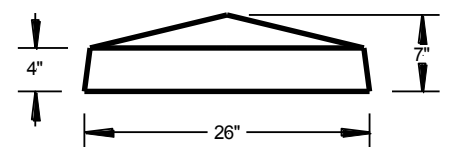

All of our pier caps can be manufactured with holes or flat spots.
Call for pricing

CAST STONE PIER CAPS

PC - BUL26

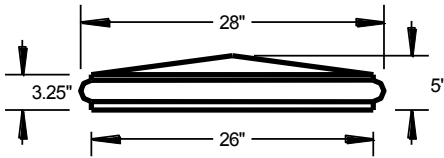

PC-BUL26A

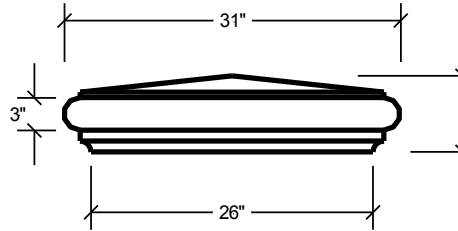

PC - 26D

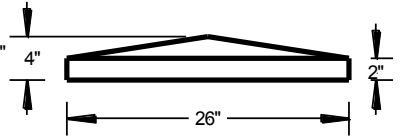

PC - 27D

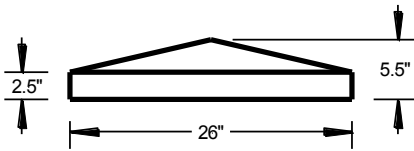

PC - 34

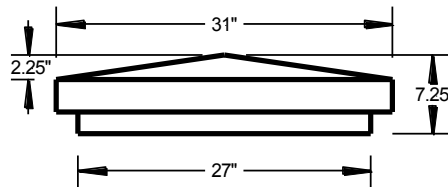

PC - 60

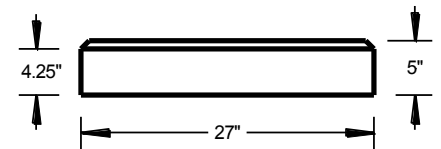

PCFT - 28

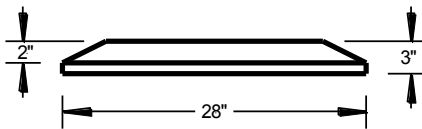

PC - BUL28

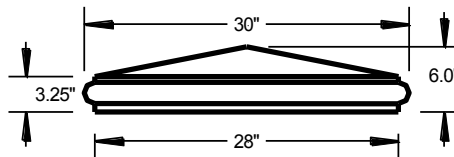

PC - 28D

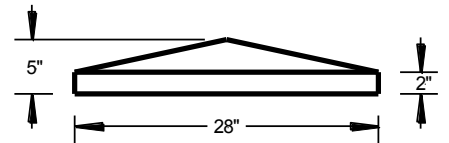

PC - 35

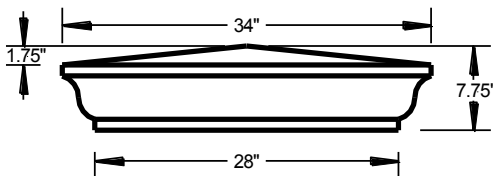

PC - 62

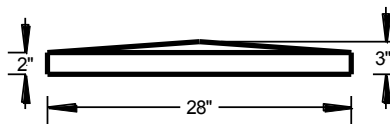

PC - 38

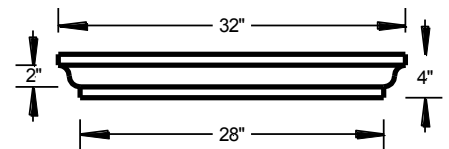

All of our pier caps can be manufactured with holes or flat spots.
Call for pricing

CAST STONE PIER CAPS

PC - 31

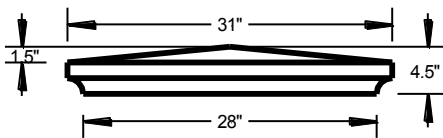

PC - 54B

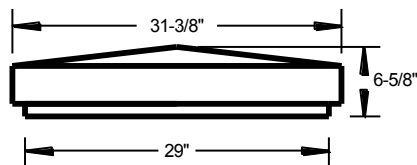

AW - 30

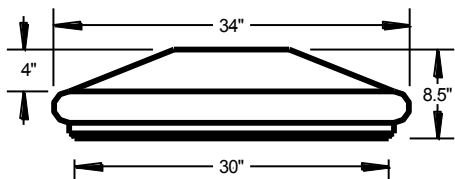

AW - 31

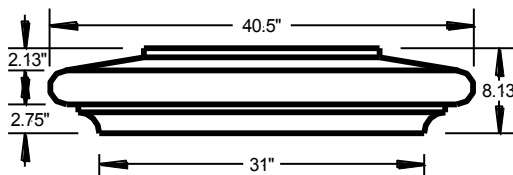

PC - 14

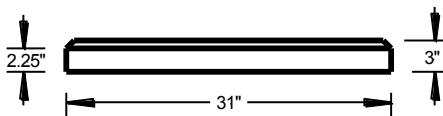

PC - 32D

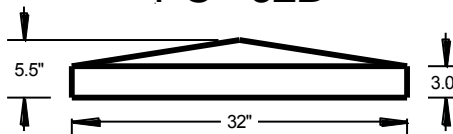

PCT - 33

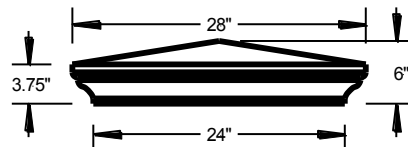
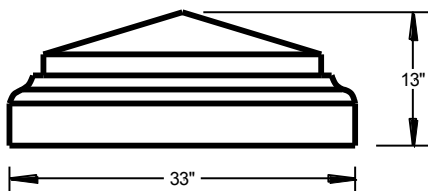

PC - 61

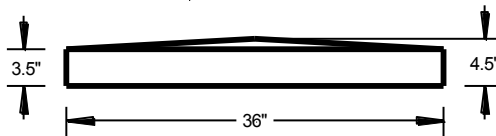

PC - 02

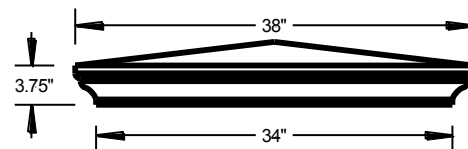

PCF - 36

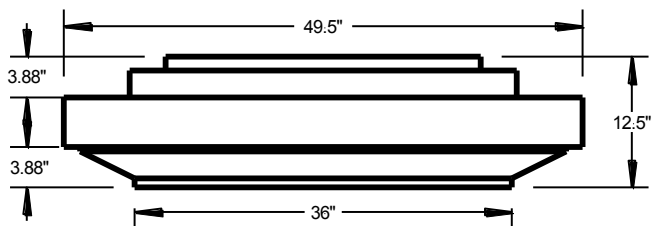

PC-15

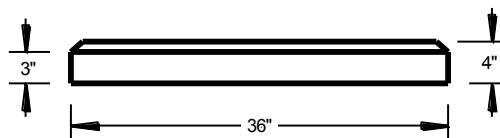

All of our pier caps can be manufactured with holes or flat spots.
Call for pricing

CAST STONE PIER CAPS

AW - 40

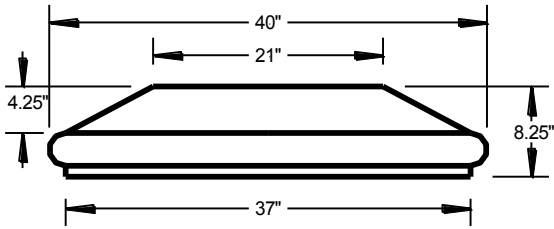

AW - 37

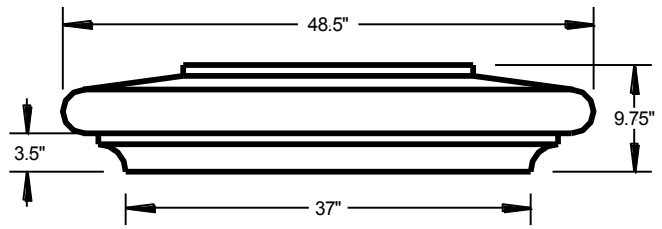

PC - 42D

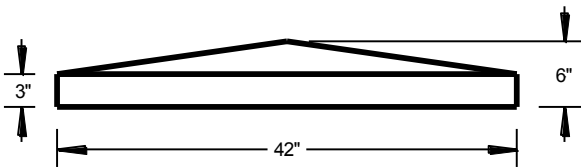

PC - 20

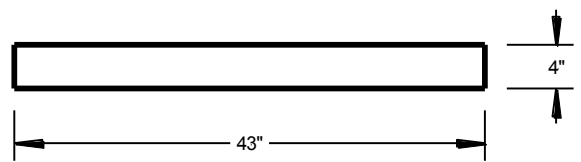

PC - 65

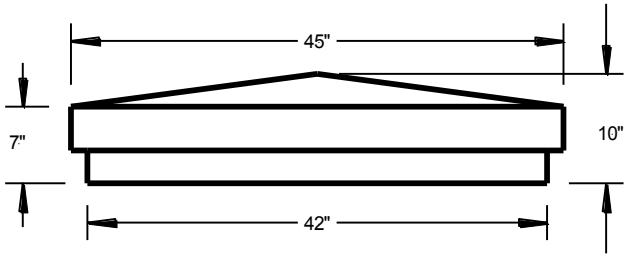

PC - 46T

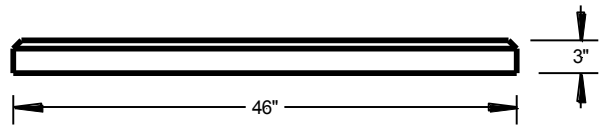

PC-17

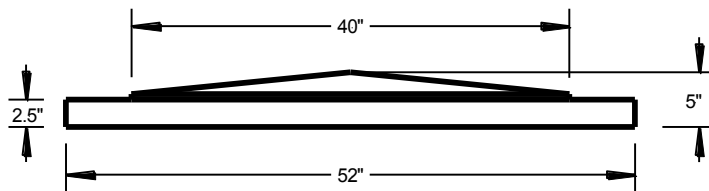

All of our pier caps can be manufactured with holes or flat spots.
Call for pricing

CAST STONE RECTANGULAR PIER CAPS

PC - 19

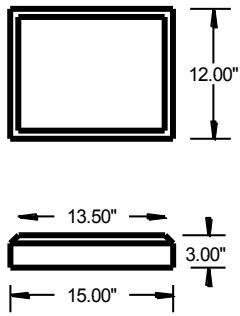

PC - CG1

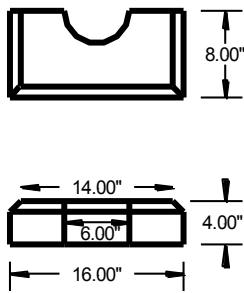

PC - 55

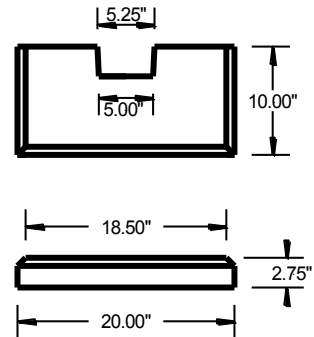

PC - 37

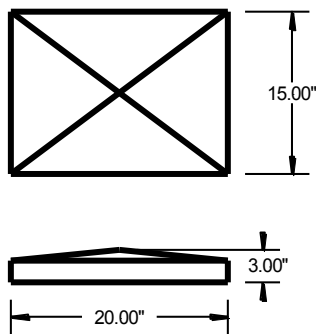

PC - 36

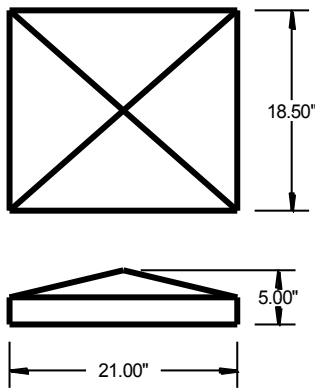

PC - 41

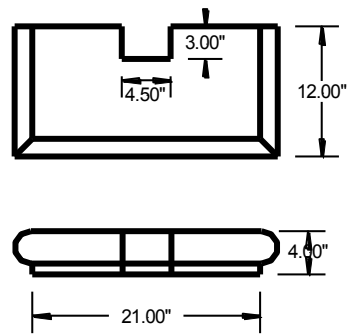

PC - 21

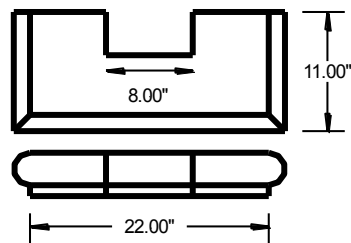

PC - 42

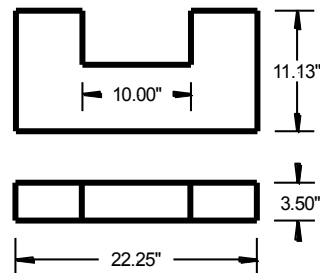

All of our pier caps can be manufactured with holes or flat spots.
Call for pricing

CAST STONE RECTANGULAR PIER CAPS

PC - 63

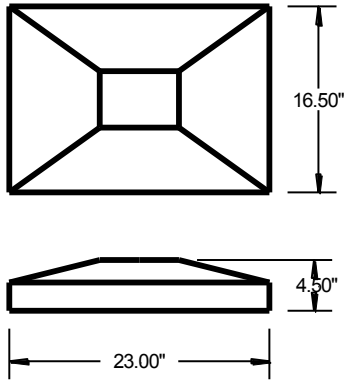

PC - 40

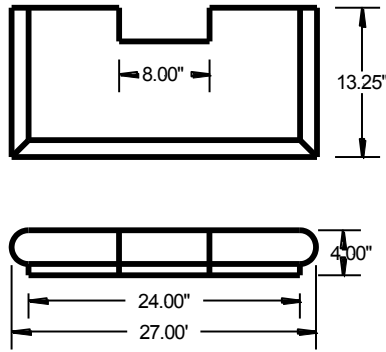

PC - 48

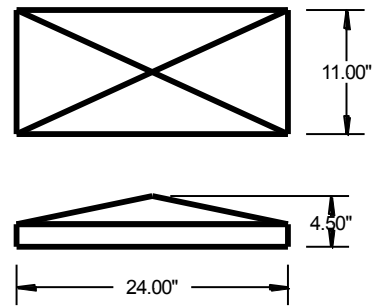

PC - 51

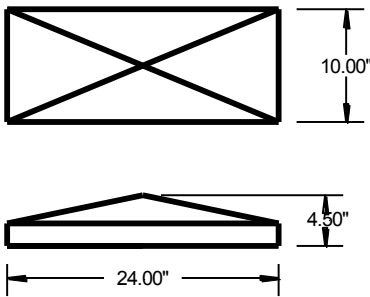

PC - 43

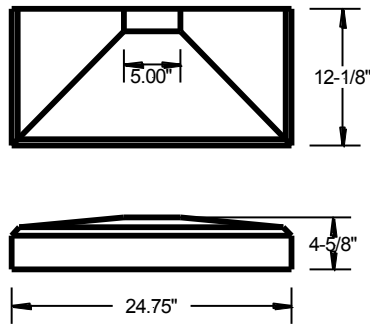

PC - 43 - 1

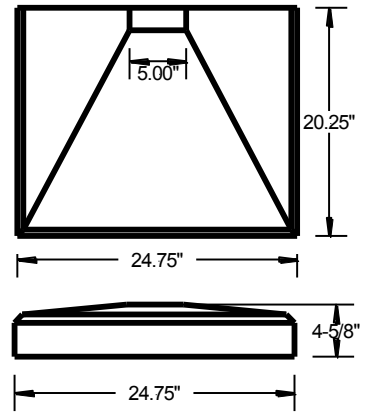

PC-6

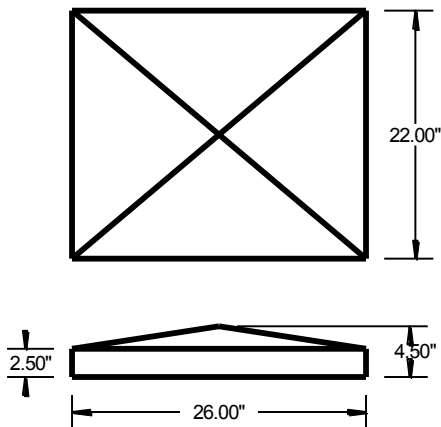

PC - 56

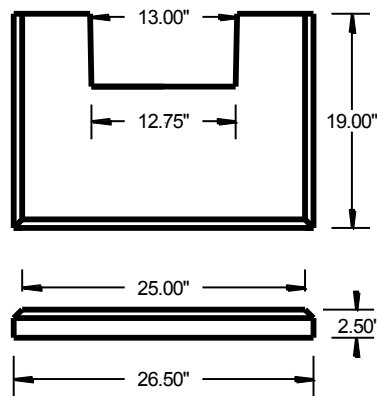

All of our pier caps can be manufactured with holes or flat spots.
Call for pricing

CAST STONE RECTANGULAR PIER CAPS

PC - 45

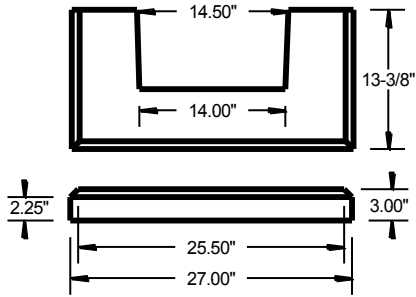

PC - 45B

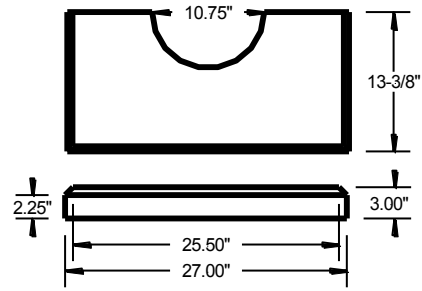

PC - 39

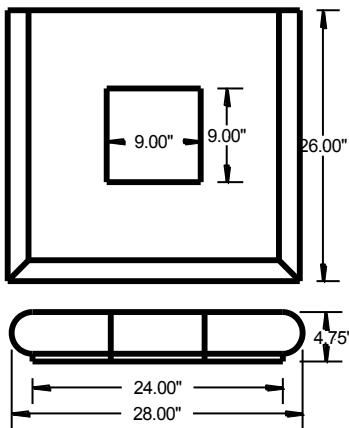

PC - 46R

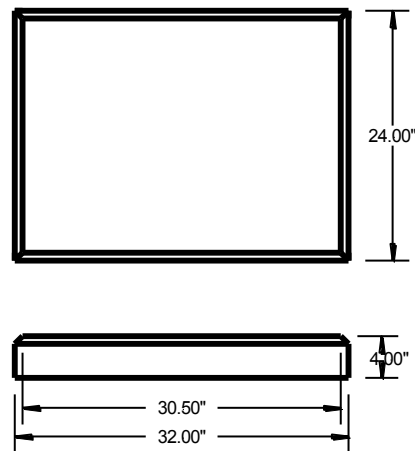

PC - 66

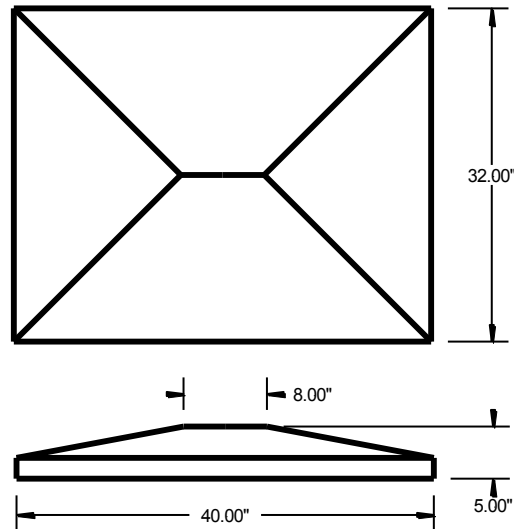

All of our pier caps can be manufactured with holes or flat spots.
Call for pricing

CAST STONE POOL COPING

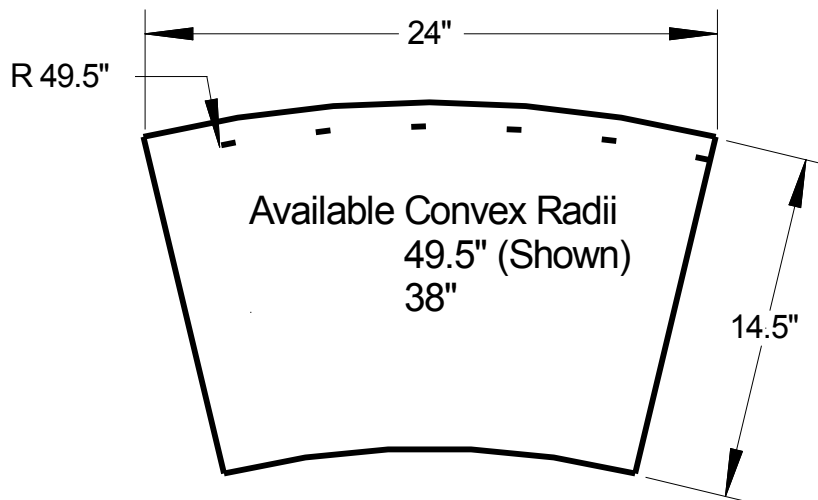
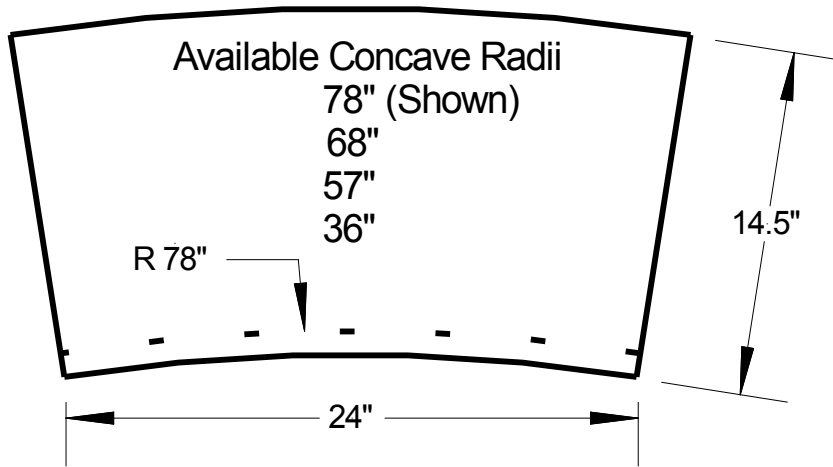
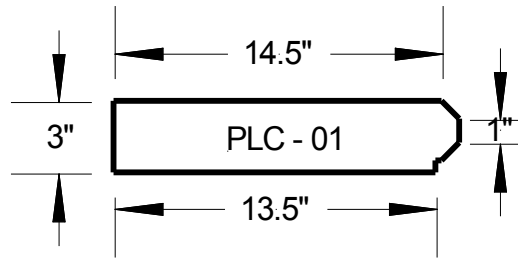

CAST STONE SQUARE CORNER SIGNS

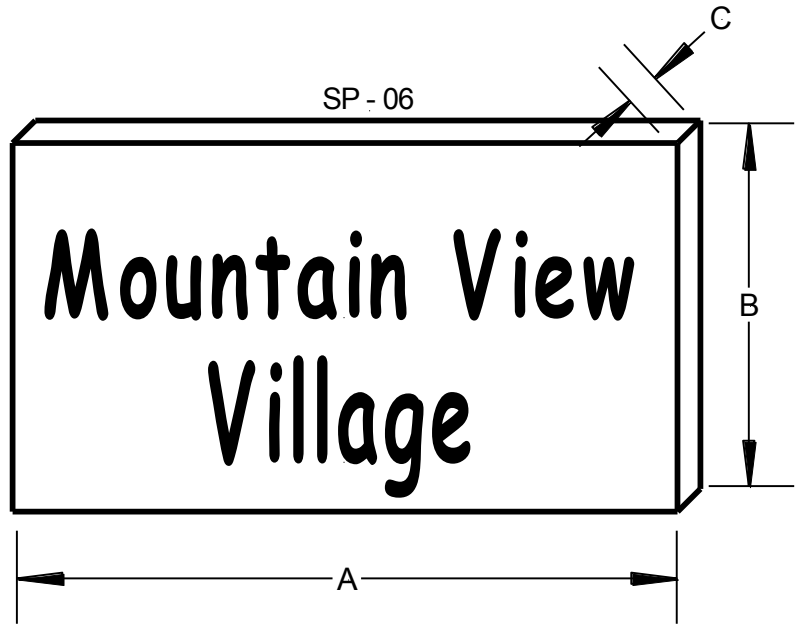
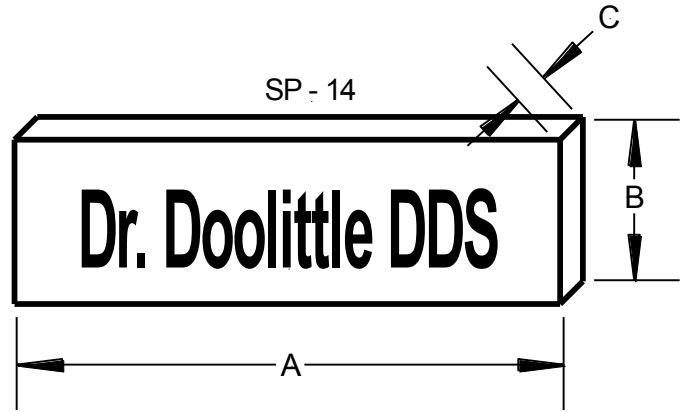
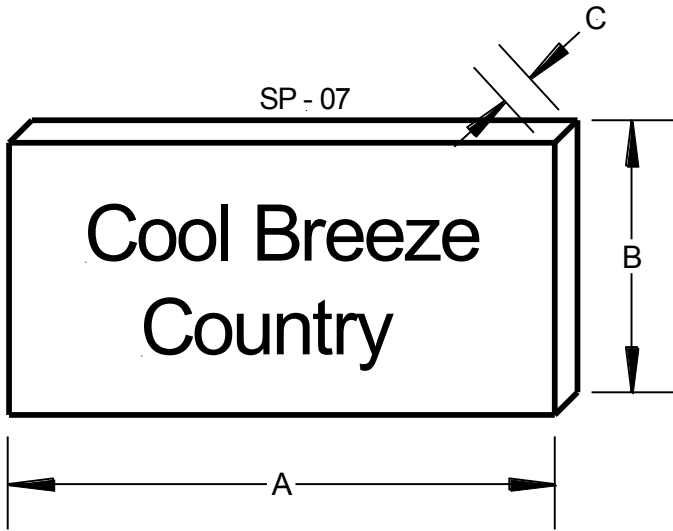

DRY PACK SIGN PANELS			
Item Number	'A'	'B'	'C'
SP - 26	24"	24"	2"
SP - 20	27.25"	27"	4"
SP - 25	30"	30"	4"
SP - 21	36"	24"	3"
SP - 13	44"	12"	3"
SP - 05	48"	11.75"	3"
SP - 14	48"	14.5"	3"
SP - 07	48"	24"	3"
SP - 02	48"	36"	2.5"
SP - 41	48"	48"	3"
SP - 12	50"	20"	2.5"
SP - 03	50"	26"	3"
SP - 09	54"	36"	3"
SP - 08	58.25"	20"	2.5"
SP - 06	58.5"	32.5"	3"
SP - 15	60"	38.5"	3"
SP - 11	70"	18.5"	3"
SP - 16	72"	24"	3"

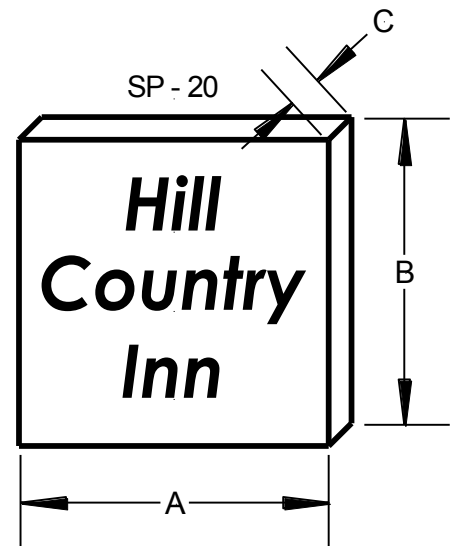
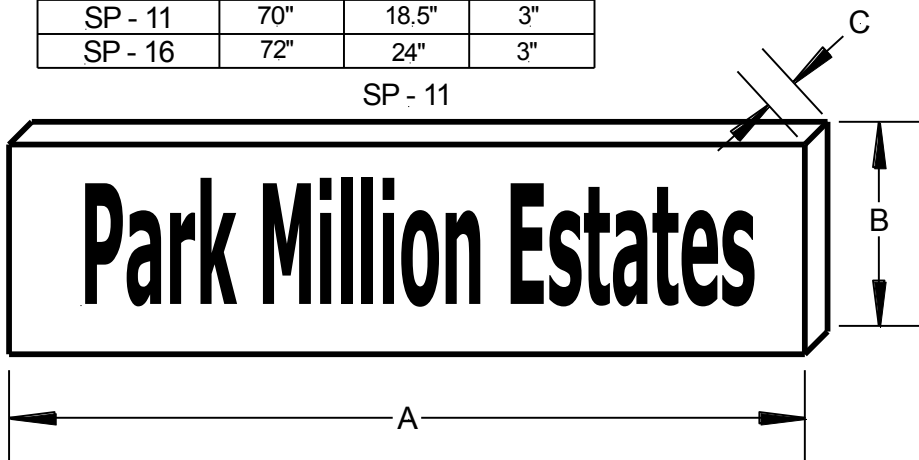

CAST STONE SQUARE CORNER SIGNS



DRY PACK SIGN PANELS			
Item Number	'A'	'B'	'C'
FP - 119	18"	18"	3"
FP - 106	23"	23"	2.5"
SP - 40	26"	26"	2"
FP - 107	27"	22.5"	2.5"
SP - 38	29.75"	20"	2.5"
FP - 78	30"	10"	2.5"
SP - 39	30"	27"	2.5"
FP - 127	31.5"	24"	2"
SP - 31	33.25"	33.25"	2"
SP - 30	34"	12"	2"
FP - 118	36"	31.25"	2"
SP - 35	40"	19.75"	3"
SP - 37	40"	24"	2"
SP - 29-1	48"	12"	2"
SP - 34	60"	24"	3"
SP - 36	63.5"	39.5"	3"
SP - 33	70"	9"	2"

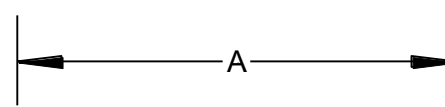
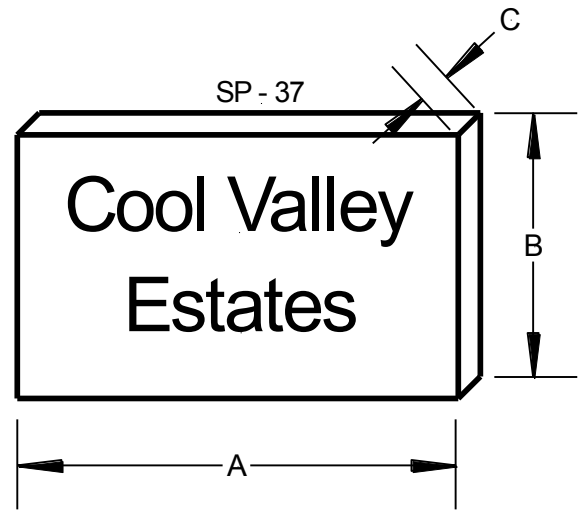
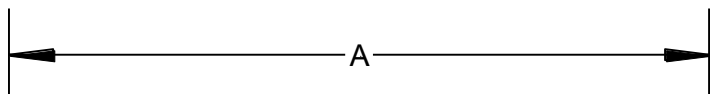
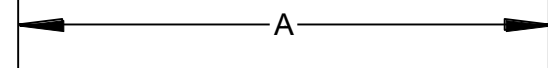
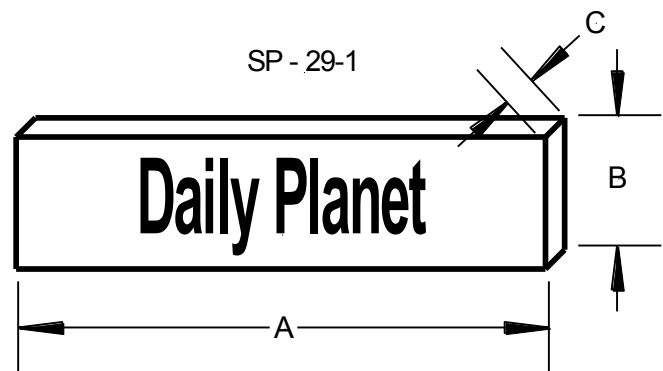
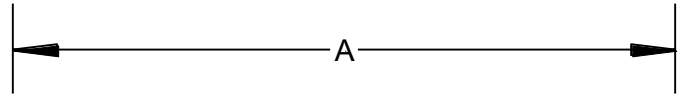

CAST STONE BEVELED EDGE SIGNS

SP - 28

SP - 28



DRY PACK SIGN PANELS w - 3/4 bevel			
Item Number	'A'	'B'	'C'
SP - 22	24"	12.5"	2.25"
SP - 19-1	24"	13.5"	3"
SP - 23	25"	12"	4"
SP - 19-2	26"	20"	5"
SP - 27	27"	20"	3"
SP - 24	36"	16"	3"
SP - 18-2	48"	30"	3"
SP - 32	52.5"	13.375"	3"
SP - 10	58"	32"	3"
SP - 28	60"	24"	3"

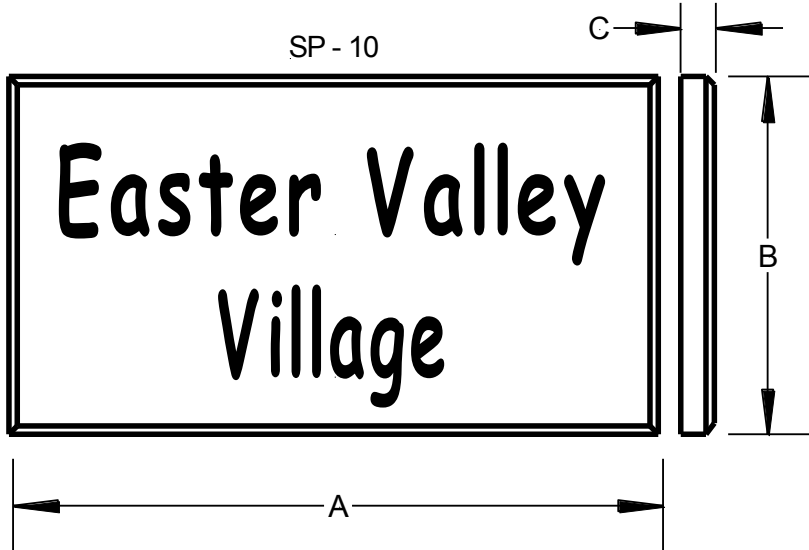
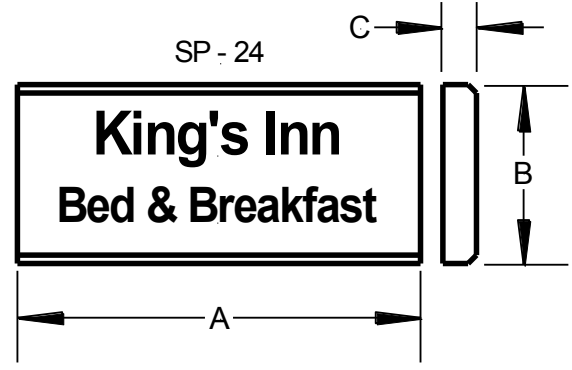
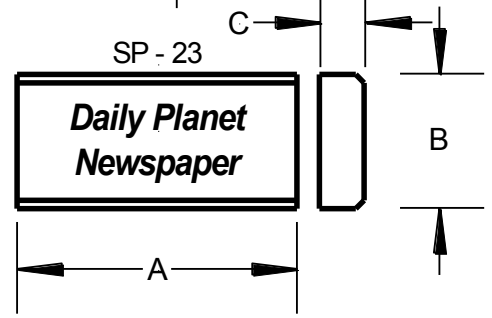
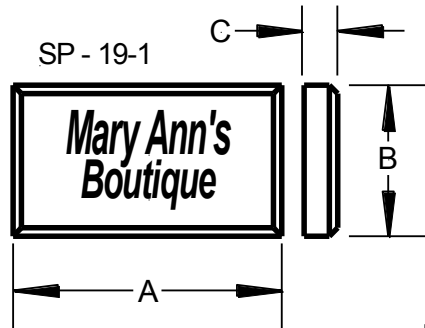

CAST STONE DESIGNER SIGNS

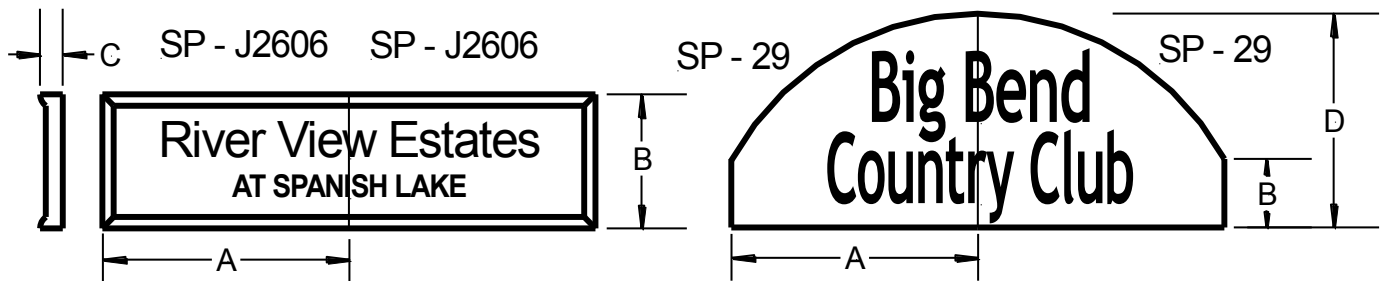
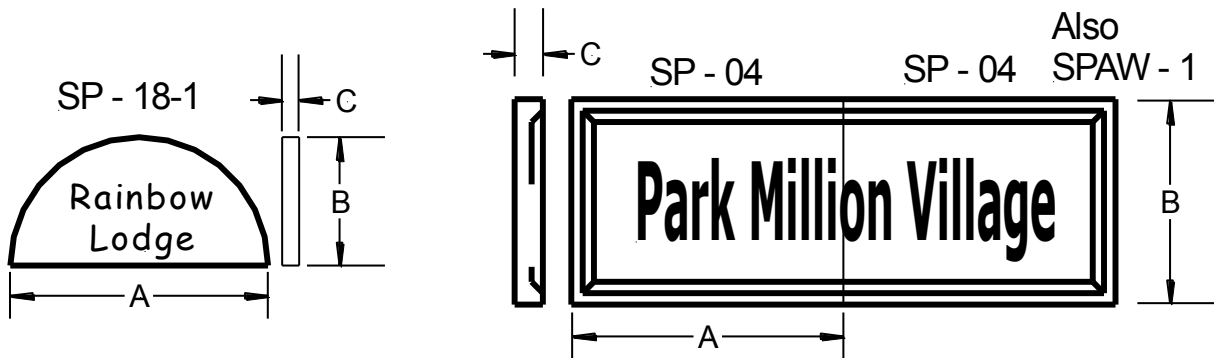

DRY PACK SIGN PANELS				
Item Number	'A'	'B'	'C'	'D'
SP - 29	43.5"	12"	3"	37.5"
SP - 18-1	45.5"	22.5"	3"	
SP - J2606	45.5"	23.5"	4"	
SP - 04	48"	36"	5"	
SPAW - 1	48.75"	42"	4"	
SP - 01	60"	38"	3"	50"
SP - 17	67"	12"	3"	30"

CAST STONE STARS



12" X 12" X 1"
ACM - 03-SR
Raised Relief Star



12" X 12" X 2"
ACM - 04-SR
Raised Relief Star

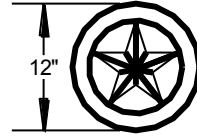

12" X 12" X 1.5"
ACM - 06-SR
Raised Relief Star

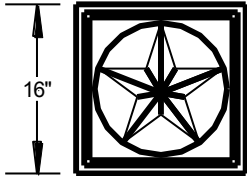

16" X 16" X 3-1/2"
ACM - 12-SR
Raised Relief Star

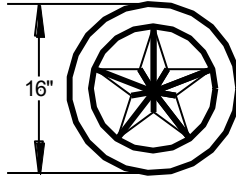

16" X 16" X 2"
ACM - 07-SR
Raised Relief Star

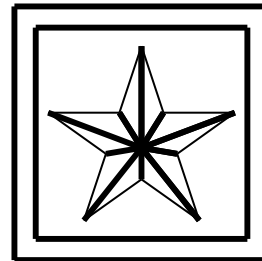

24" X 24" X 3"
ACM - 05-SR
Raised Relief Star

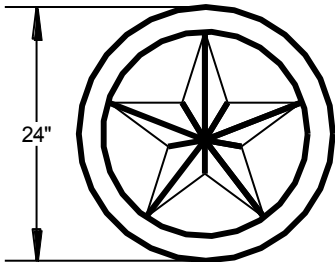

24" X 24" X 2"
ACM - 08-SR
Raised Relief Star

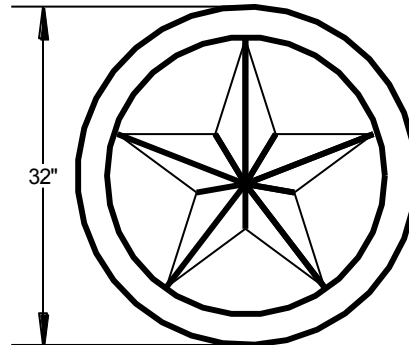

32" X 32" X 2.25"
ACM - 09-SR
Raised Relief Star

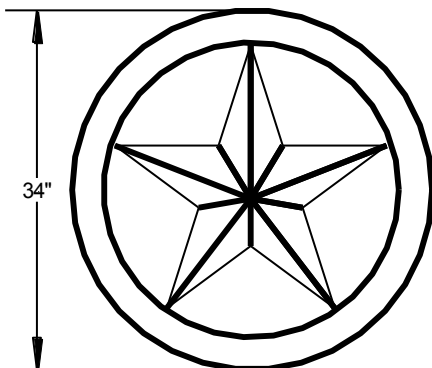

34" X 34" X 2.25"
ACM - 10-SR
Raised Relief Star

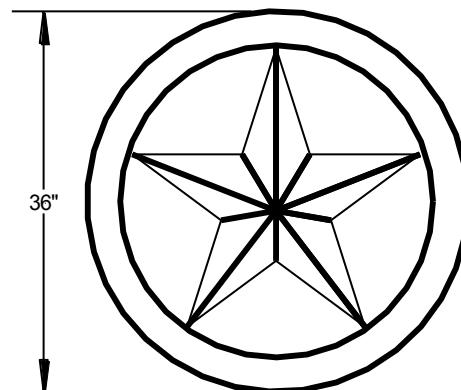

36" X 36" X 2.25"
ACM - 11-SR
Raised Relief Star

Cast Stone Vent Blocks

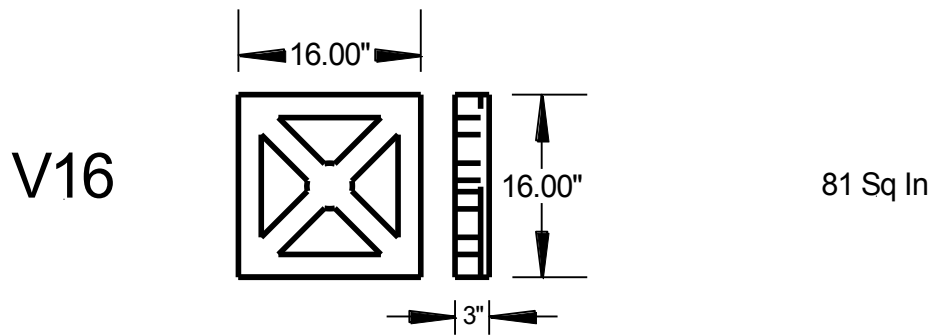
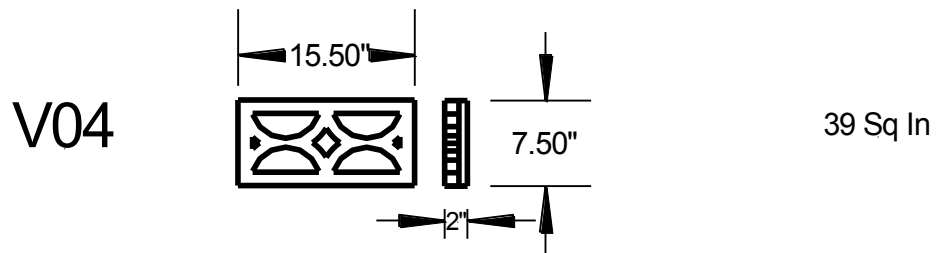
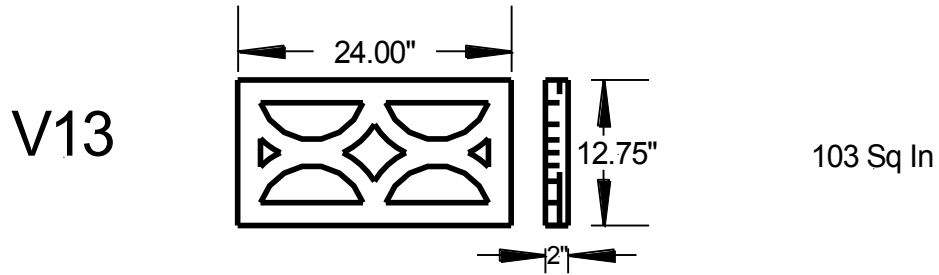
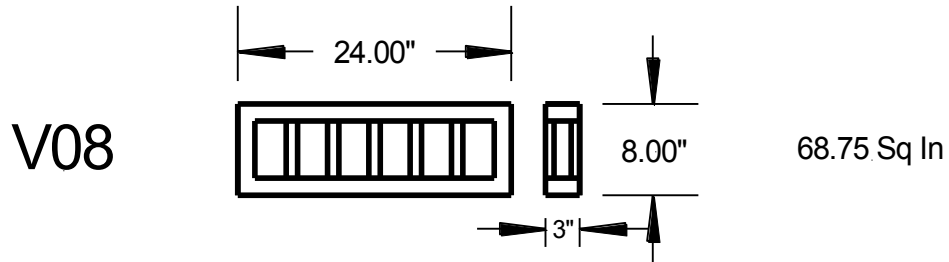
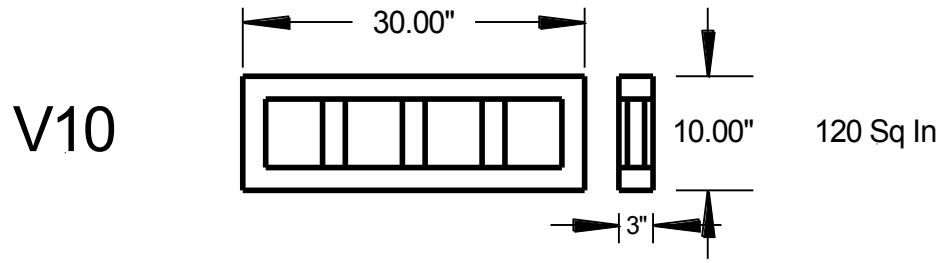

CAST STONE WALL CAPS

WC - 43
L = 34.75"

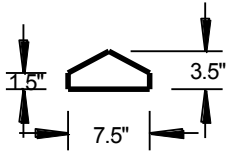

WC - 18
L = 36"

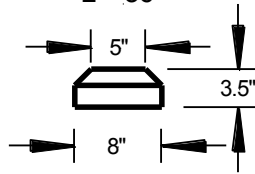

WC - 36
L = 36"

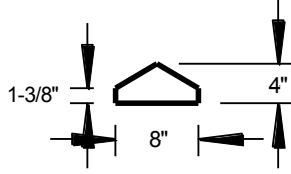

WC-11
L = 25"

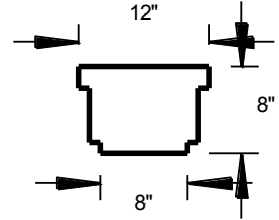

WC - 50T
L = 30"

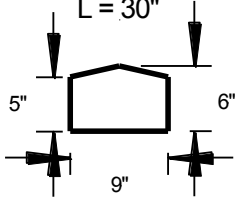

WC - 32T
L = 24"

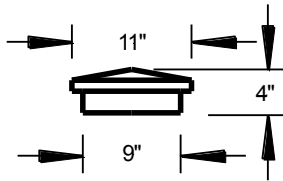

WC - 17
L = 30"

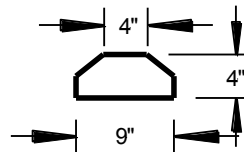

WC - 04T
L = 24"

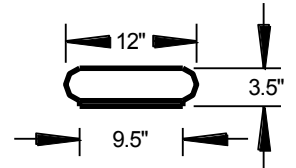

WC - 46T
L = 24", TL = 32"

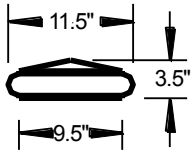

WC - 05
L = 24"

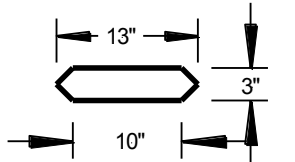

WC - 26
L = 28"

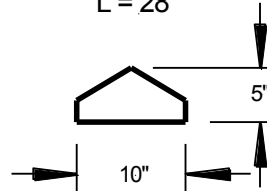

DWC 10T
L = 32"

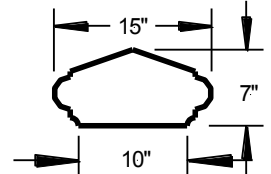

BR - 48
L = 48"

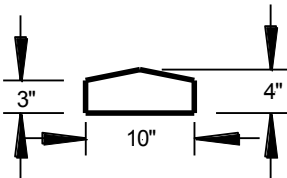

WC - 45
L = 36
R = 144", 31"

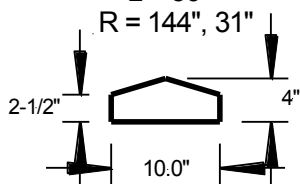

WC - 12
L = 36"

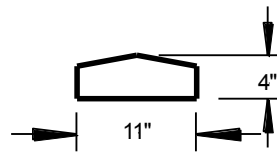

WC - 38
L = 34.5"

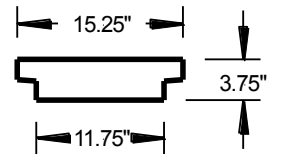

WC - 02
L = 24"

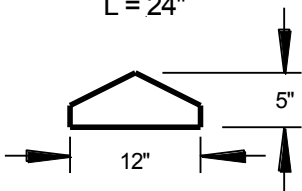

WC - 03T
L = 24"

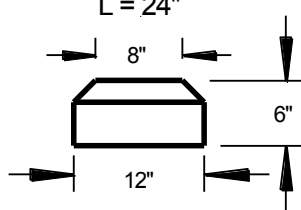

WC - 06
L = 24"

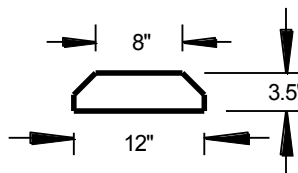

WC - 07T
L = 24"

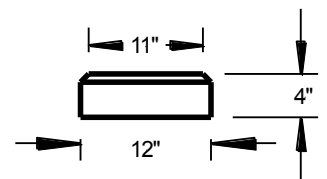

CAST STONE WALL CAPS

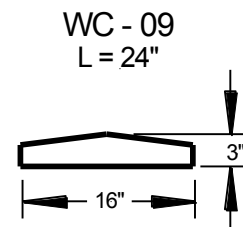
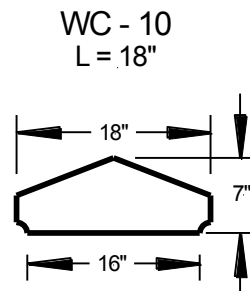
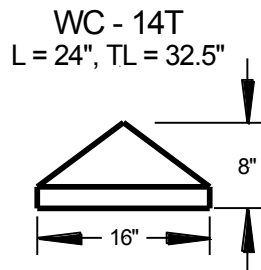
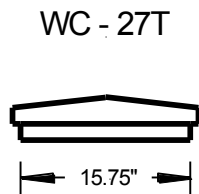
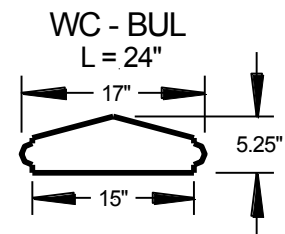
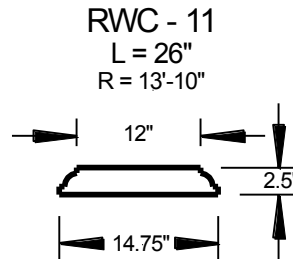
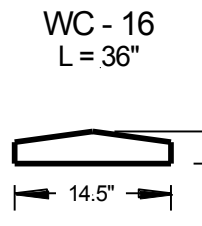
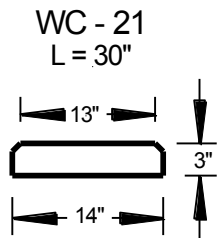
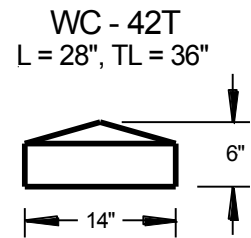
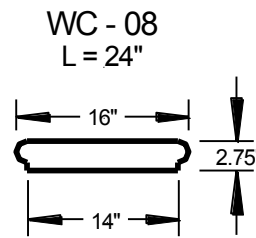
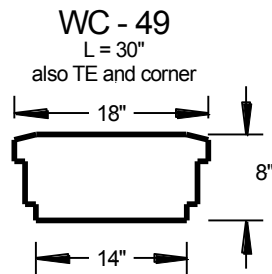
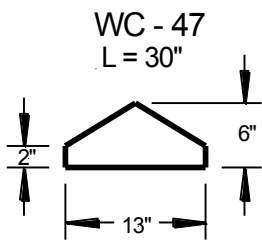
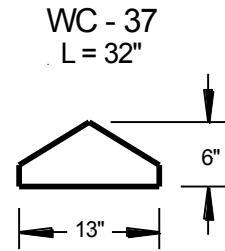
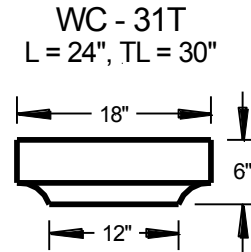
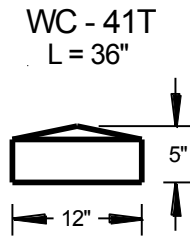
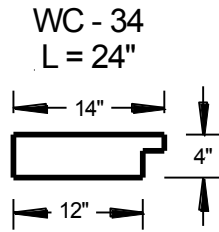
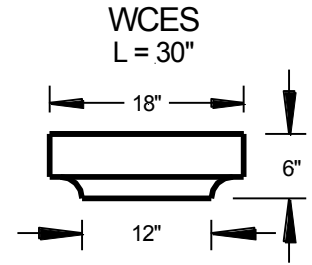
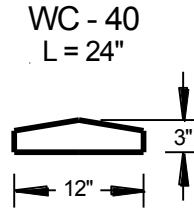
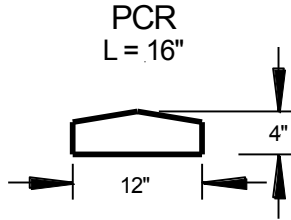
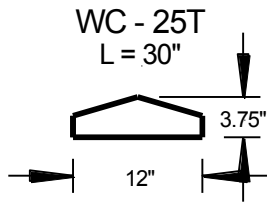

CAST STONE WALL CAPS

WC - 19
L = 29.5"

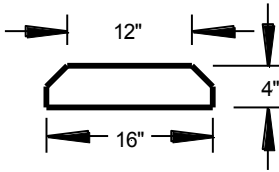

WC - 35
L = 30"

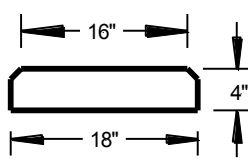

WC - 01
L = 24"

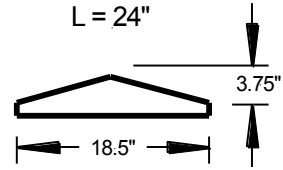

WC - 29
L = 24"

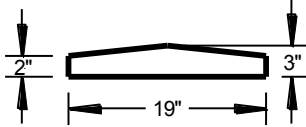

WC - 15
L = 27"

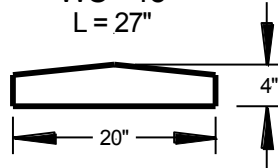

WC - 20
L = 36"

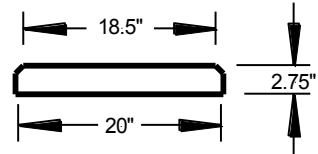

WC - 44T
L = 38.5"

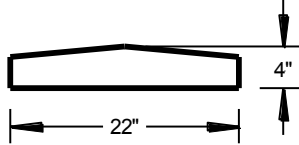

WC - 13T
L = 46"

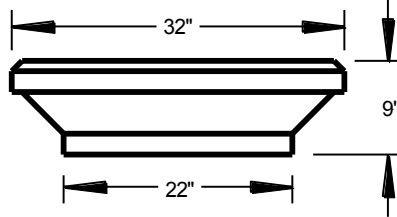

PC - 46B
L = 36"

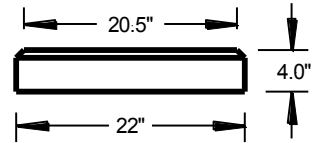

WC - 28

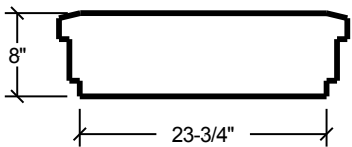

WC - 33
L = 60"

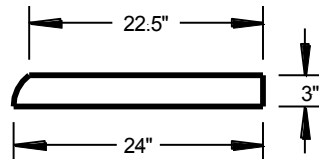

WC - 48
L = 30.75"

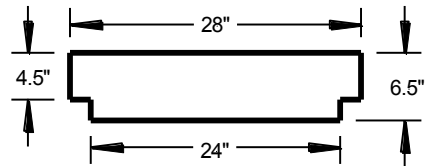

WCB - 24T
L = 35"

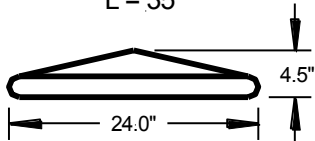

WC - 24
TE = 36"
L = 23"

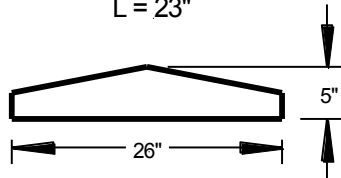

WC - B
L = 38"

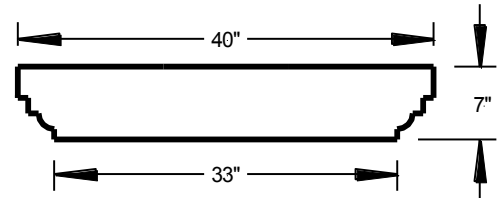

WC - 23
L = 39", TE

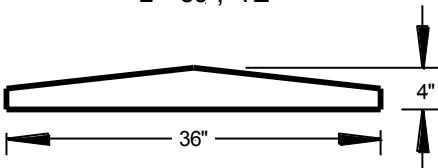

WC - 22
TE = 49"
L = 28.5"

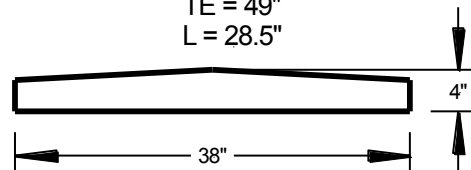

CAST STONE WATER TABLE

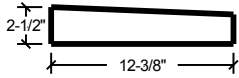

SL-18
L&R Returns
24" length

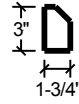

SL - 12
30" Length

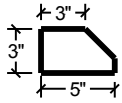

SL - 14
36" Length

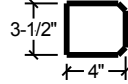

SL - 23
38.5" Length

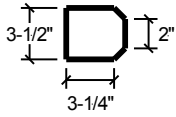

SL - 34
38.5" Length

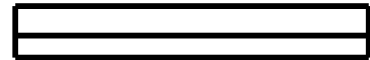
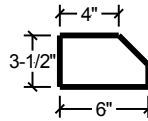

SL - 03
36" Length

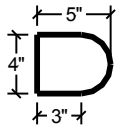

BN - 4
36" Length

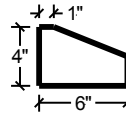

SL - 06
40" Length

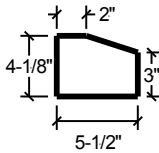

SL - 16
36" Length

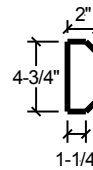

FP - 53
24" Length

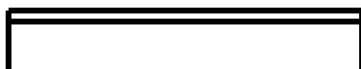
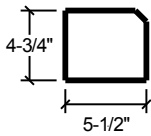

SL - 26
42.5" Length

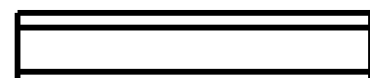
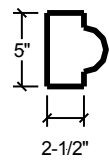

BM - 03
24" Length

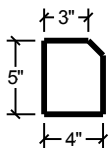

SL - 13
24" Length

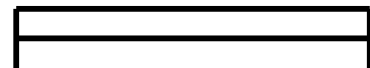
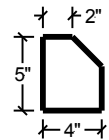

SL - 07
24" Length

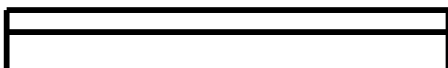
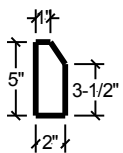

SL - 11
30" Length

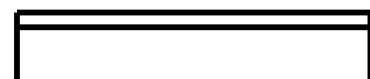
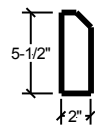

SL-01
no returns
24" length

CAST STONE WATER TABLE

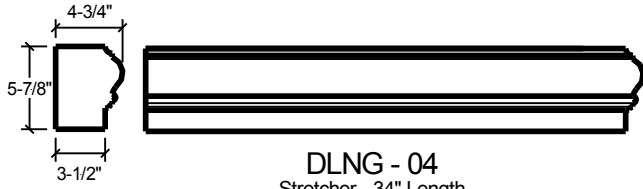

DLNG - 04
Stretcher - 34" Length
Returns - 31" Length

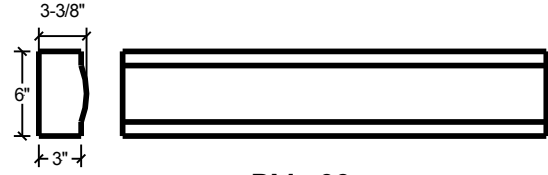

BM - 06
30" Length

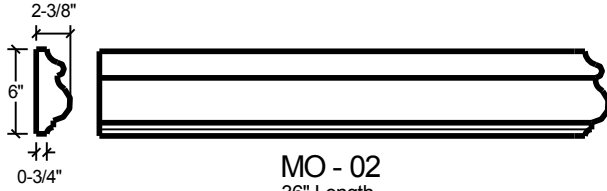

MO - 02
36" Length
Returns - 30" Length
Radii available: 28", 30", 29", 19.5"



SL-19
L&R Returns
40" length



MO - 03
36" Length
Radii available: 40", 39", 37", 66"

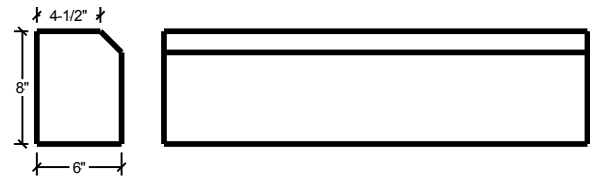

SL - 20
No returns
Stretcher - 30" Length

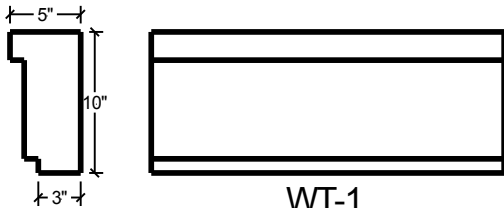

WT-1
L&R Returns
25" length

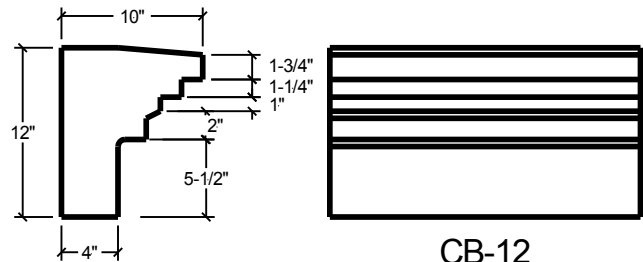

CB-12
L&R Returns
42" length

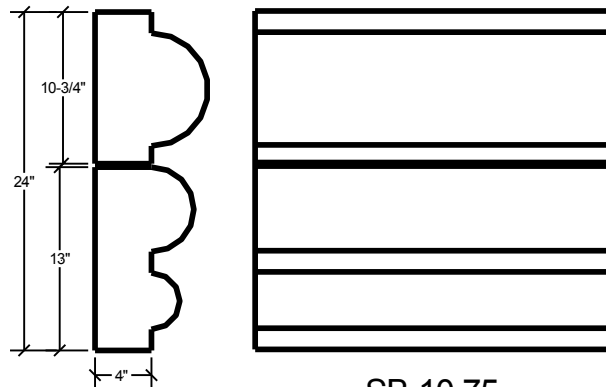

SB-10.75
L&R Returns
24" length

CAST STONE WINDOWSILLS

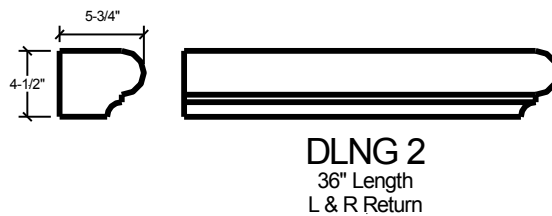
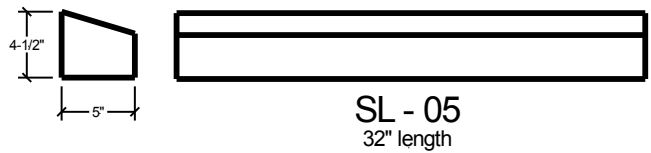
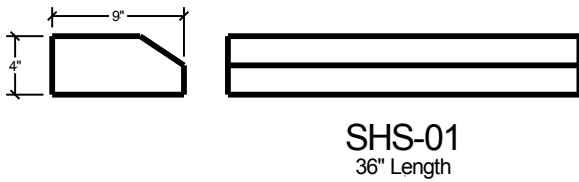
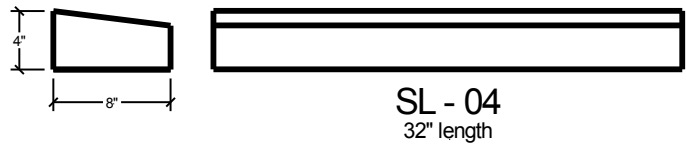
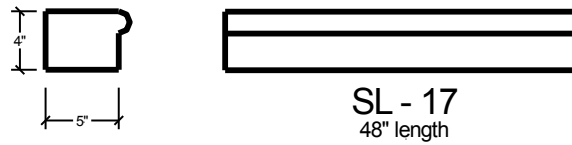
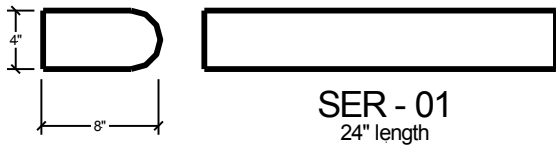
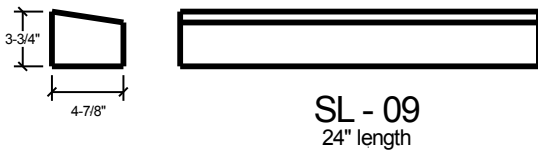
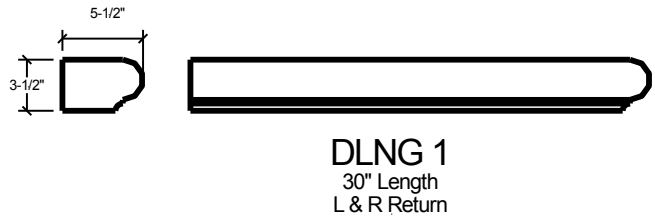
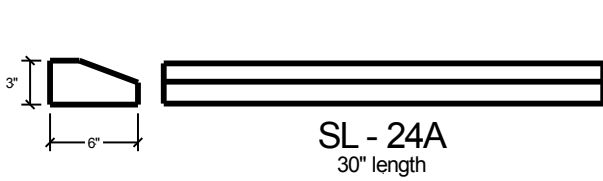
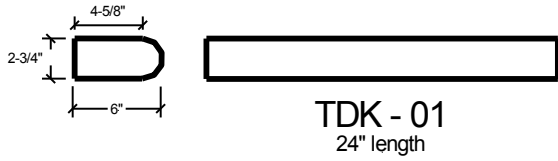

CAST STONE WINDOWSILLS

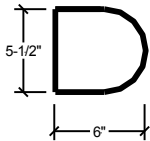

ACM - 01
48" length

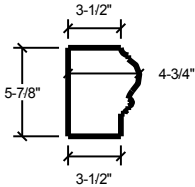

DLNG 4
31" Length
L & R Return

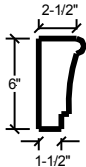

ZM-02
36" Length
L & R Return

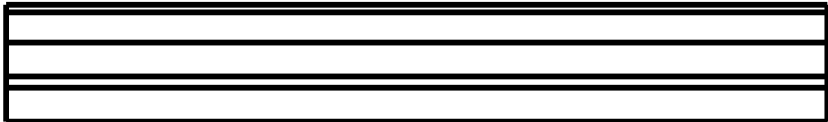
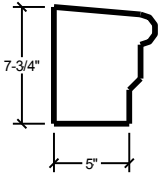

BM - 12
54.5" length

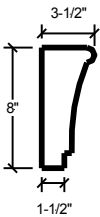

ZM-01 BLOK
36" Length
L & R Return

CAST STONE WINDOW SURROUNDS

WSRD(radius)

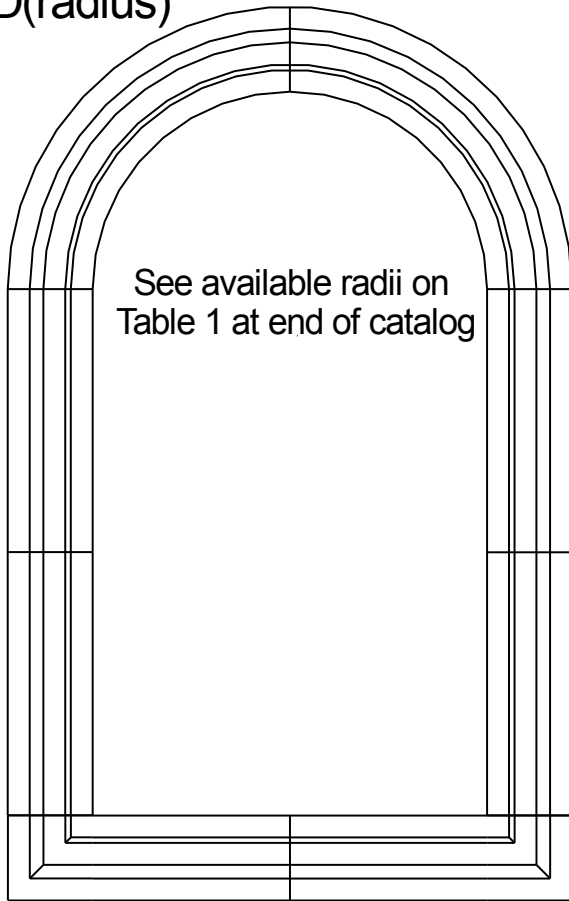

WSSD

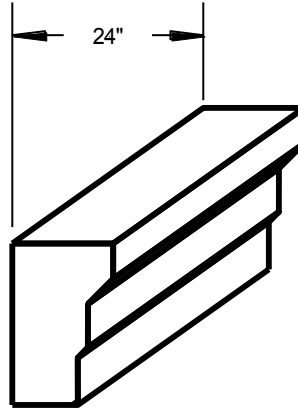

WSSD
Return

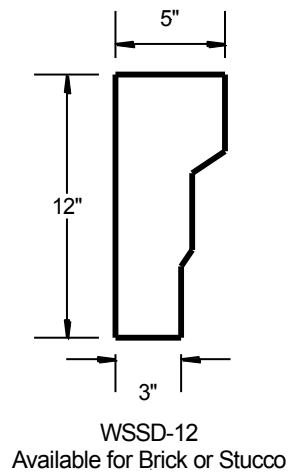
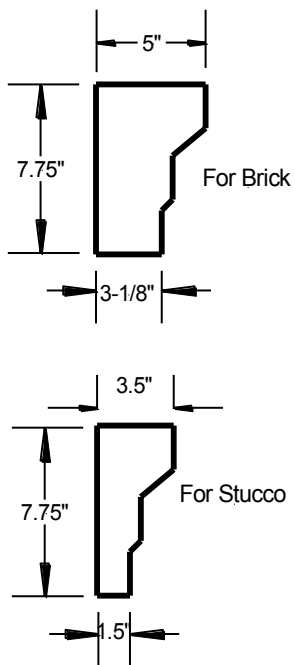
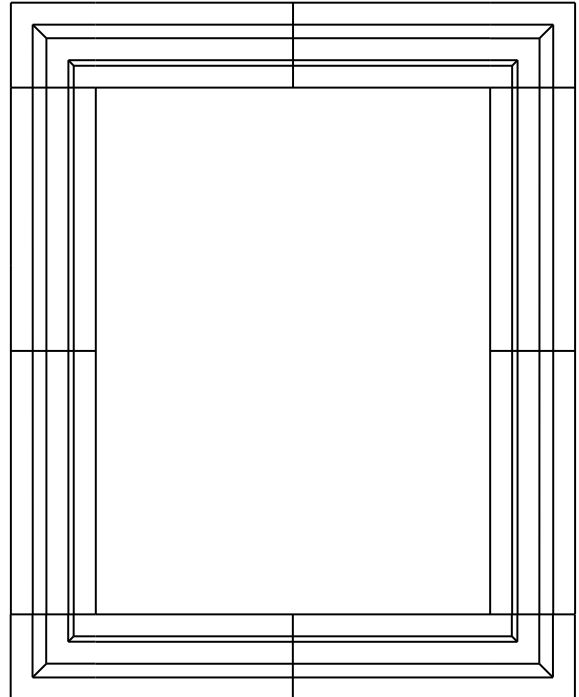

CAST STONE WINDOW SURROUNDS

Double Chamfer

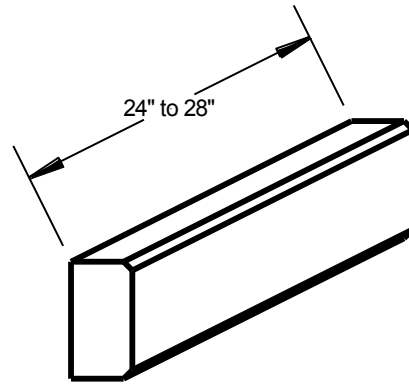
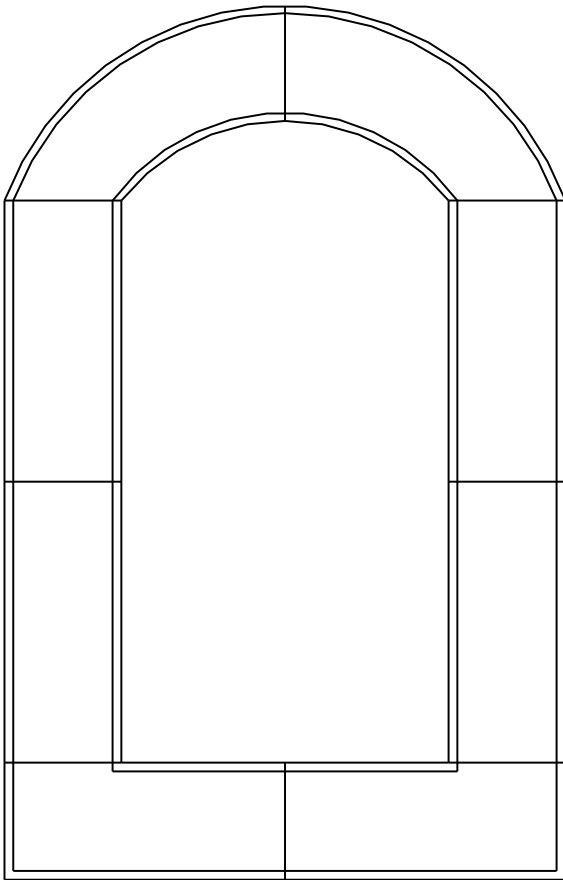

See available radii on
Table 2 at end of catalog

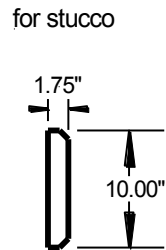
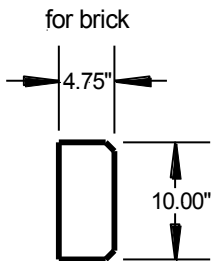
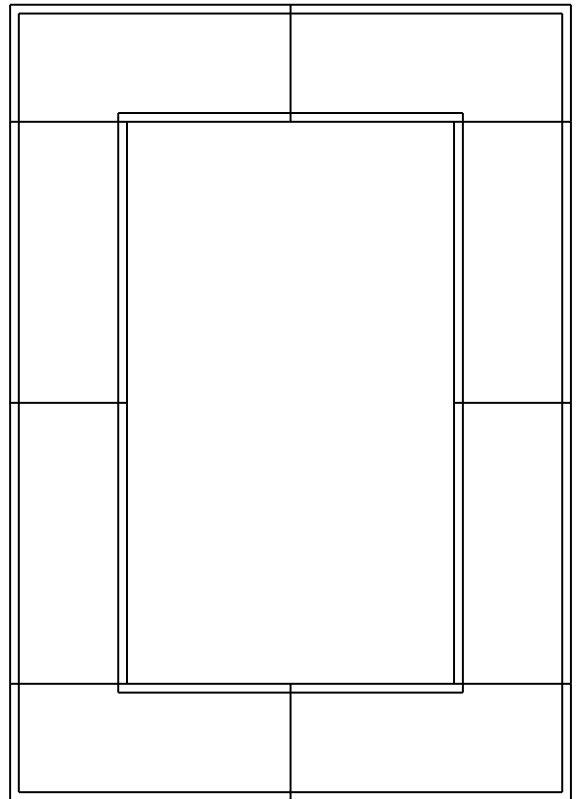

heights available in 4", 5", 6", 8", 10", 12" with 3/4" chamfer
and same depths as shown

CAST STONE WINDOW SURROUNDS

See available radii on
Table 3 at end of catalog

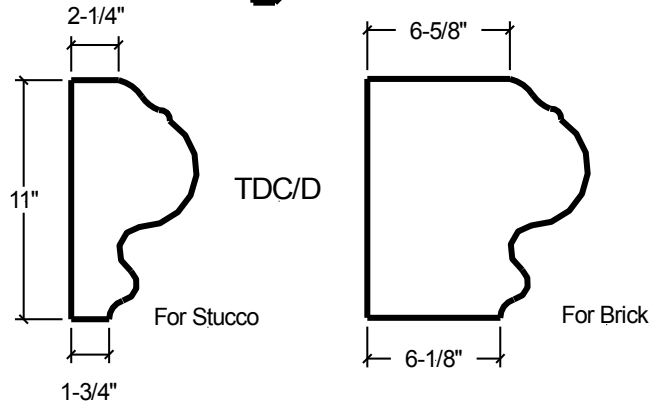
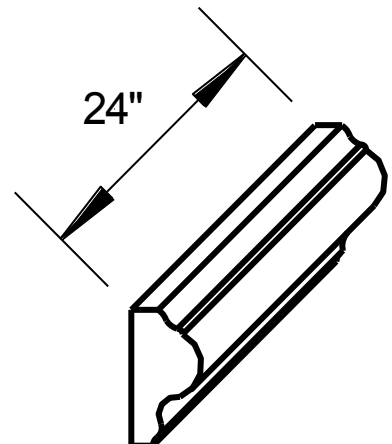
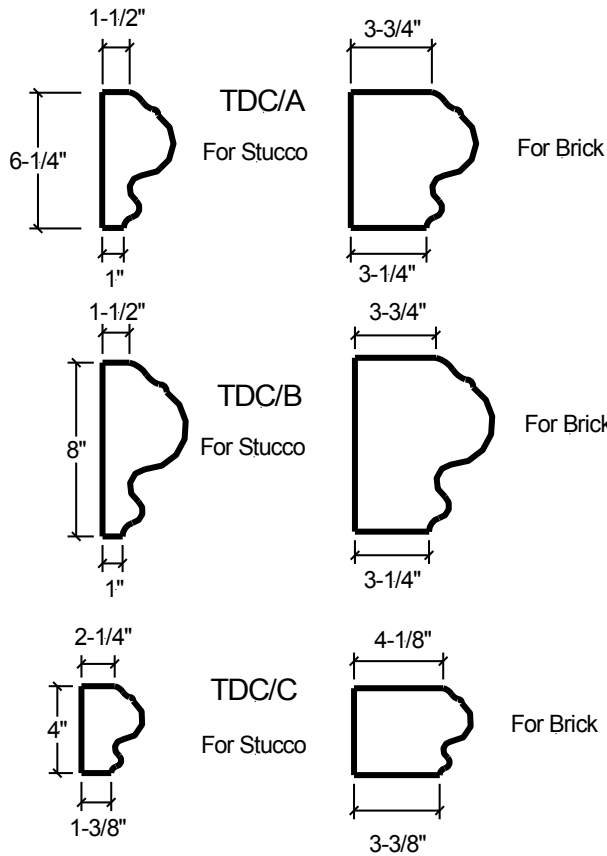
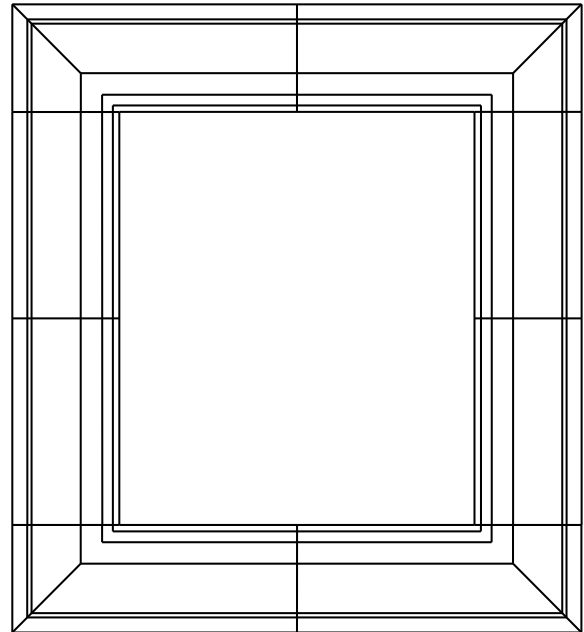
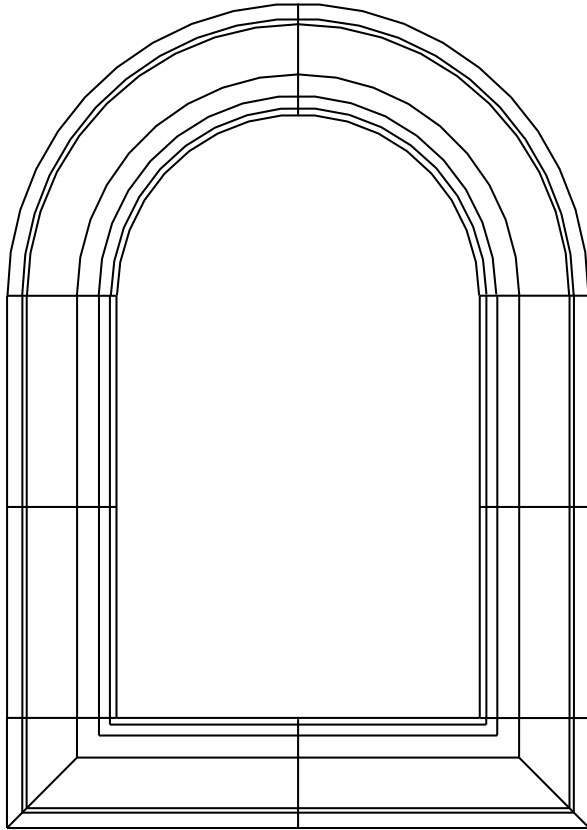

TABLE 1

WSRD - WINDOW SURROUND

WSRD 8"		WSRD 12"
Radius	Length	Radius
9"	26"	36"
12"	31 3/4"	44"
15"	36"	48"
17"		66"
18"	40"	72"
20"	43 1/2"	
24"		
28"	28 1/4"	
30"	29"	
33"	32"	
36"	34 1/4"	
39.5"	24"	
42"	33 1/2"	
48"	29 1/2"	
48"	32"	
54"		
60"	35 1/2"	
66"	20 1/2"	
72"	33 5/8"	
84"	32"	
7' 6"	30"	
8' 6"	32"	
9' 6"		
11' 3"	24"	
17'	25"	
54'	34 1/4"	

TABLE 2

DOUBLE CHAMFER - WINDOW SURROUND

DC - 4"
Radius
12"
18"
21"
24"
30"

DC - 5"
Radius
25"
29"

DC - 6"	
Radius	Length
6"	
8"	24"
12"	
15"	
17"	23"
18"	
23' 6"	40"
23' 6"	41 3/7"
24"	24"
26"	
36"	
50"	
51 7/8"	
52"	
60"	35"
62 1/4"	
72"	26"
80"	
84"	38"
92 3/4"	

DC - 8"	
Radius	Length
12"	32"
18"	40"
24"	50"
30"	38"
36"	33"
39"	
44"	
50"	41"
54"	38"
64"	
72"	40"
7' 6"	36"
14' 2"	38"
21'	42"
28'	
38'	36"
40' 5 1/2"	
54'	36"

DC - 10"
Radius
18"
24"
27"
36"
44"
14'
50.5'

DC - 12"
Radius
39"
45"
51 7/8"
61 1/4"
92 3/4"

TABLE 3

TDC/A, B, C - WINDOW SURROUND

TDC/A			
Radius	Length	Radius	Length
10"	22"	42"	36"
10"	23"	42"	47"
12"	25"	42"	48"
13 1/2"	27"	42"	37"
15"	30"	48"	27"
17"	32"	51"	
18"	34"	56"	33"
19"	35"	60"	34"
20"	38"	66"	26"
20"	36"	72"	36"
21"	38"	72"	39"
22"	36"	84"	32"
24"	40"	84"	33"
24"	45"	7' 6"	26"
24"	30"	7' 11"	32"
27"	33"	9' 6"	31"
28"	25"	9' 6"	32"
30"	36"	12'	32"
33 7/8"	30"	13' 5"	
33"	30"	25'	31"
36"	42"	38'	30"
38"	33"	38'	30 1/2"
39"	34"		
39"			
39 3/8"	35"		
39 3/8"	36"		

TDC/B			
Radius	Length	Radius	Length
6 3/4"		58 3/4"	30"
11"	26"	60"	35"
11"	30"	60"	36"
15"	32"	63 1/4"	30"
15"	33"	64 1/4"	36"
18"	36"	65"	33"
18"	37"	65"	50"
20"	39"	65"	51"
22"	30"	65"	33"
22"	42"	78"	42"
24"	45"	84"	30"
24"	49"	9'	38"
26"	48"	12' 10 1/2"	36"
26"	54"	14'	37"
30"	29"	14' 4"	
33"	41"	54'	36"
36"	33"		
38"	35"		
38"	36"		
39 3/8"	36"	1 R	30"
42"	27"	1 L	30'
48"	26"	1 ST	24"
48"	28"		
53"	31"		
53"	33"		

TDC/C
Radius
9 1/2"
12"
13"
18"
21"
24"
69"