

BELGARD
PAVES THE WAY



2017 PRODUCT CATALOG

-  BRITTANY BLEND
-  BROWNSTONE
-  DARVILLE BLEND
-  SABLE BLEND
-  SILEX BLEND

MODULAR
TEXTURED
TIMELESS



LAFITT PAVER

*Available in colors of a Field & Farm

-  BRITTANY BLEND
-  BROWNSTONE
-  DARVILLE BLEND
-  SABLE BLEND
-  SILEX BLEND

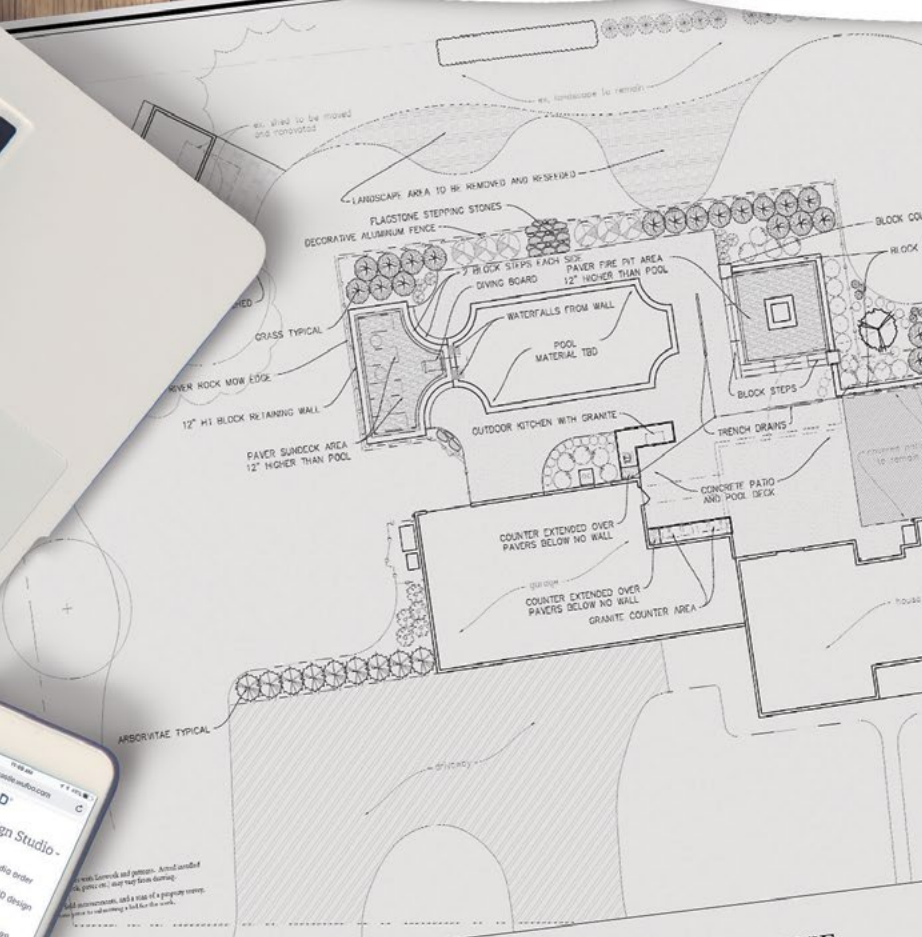

DRAWN: DL
 CHECKED: DL
 DATE: JULY 2017

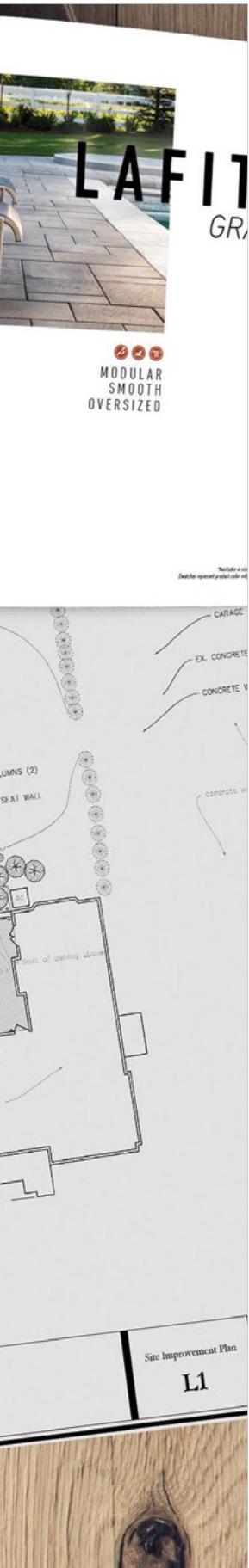

STEVENS RESIDENCE

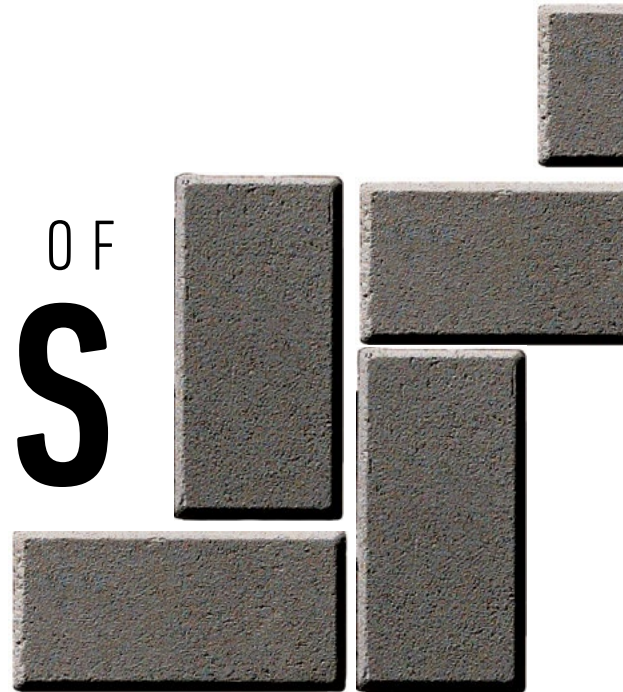

YOUR JOURNEY STARTS HERE

TABLE OF CONTENTS



4	Style Guide
18	Inspiration
 36	Pavers & Slabs
 64	Walls
 86	Fire Features



70

Lafitt Tandem

NOTE: Belgard® can not guarantee printed color swatches will match actual product. All colors shown are approximate representations of the standard product. Actual colors may vary slightly due to batch variances and environmental conditions at time of photography. Actual sizes may vary by region. Please contact your local Belgard representative for accurate samples, availability and pricing.

50

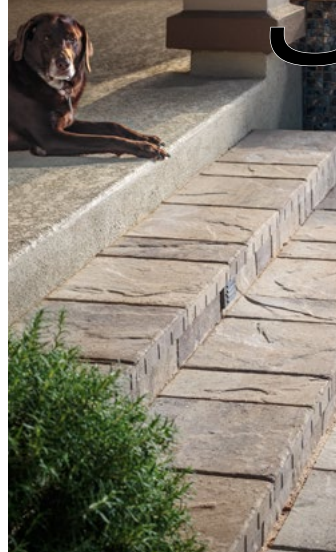

Lafitt Rustic Slab

60



Turin Porcelain Pavers

Holland Stone

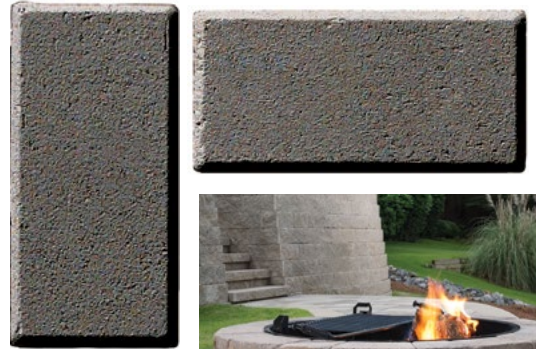

Weston Stone Fire Pit Kit

89

TIMELESS & TRENDING





THE ESSENCE OF OUTDOOR LIVING.

The primary goal in designing an outdoor living room is to create a space that invites you to spend time outdoors. Whether you enjoy entertaining large groups or prefer an intimate space for curling up with a good book, Belgard® is your source for patio designs that bring the outdoors to life.



Follow Belgard on Pinterest at
[Pinterest.com/Belgard](https://www.pinterest.com/Belgard)

**RANDOM EDGE
SILHOUETTES ARE
RETURNING TO FOCUS IN
CONTEMPORARY WAYS**

Pictured: Mega-Arbel Patio Slab



NATURAL CONNECTION. CONTEMPORARY FOCUS.



**ENTANGLEMENT
BETWEEN PAVERS
AND NATURAL
LANDSCAPES IS A
GROWING DESIGN TREND.**

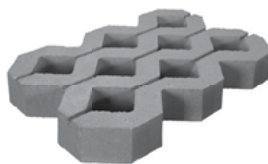

**ESCAPE TO
THE ELEMENTS**

Current nature-led trends are inspired by blending raw nature and earthen landscapes with the contemporary built environment. This evolution adds a more organic, rugged and imperfect aesthetic.

*Pictured: Custom
Weston Stone Fire Pit
Mega-Arbel Patio Slab*

BACK TO NATURE

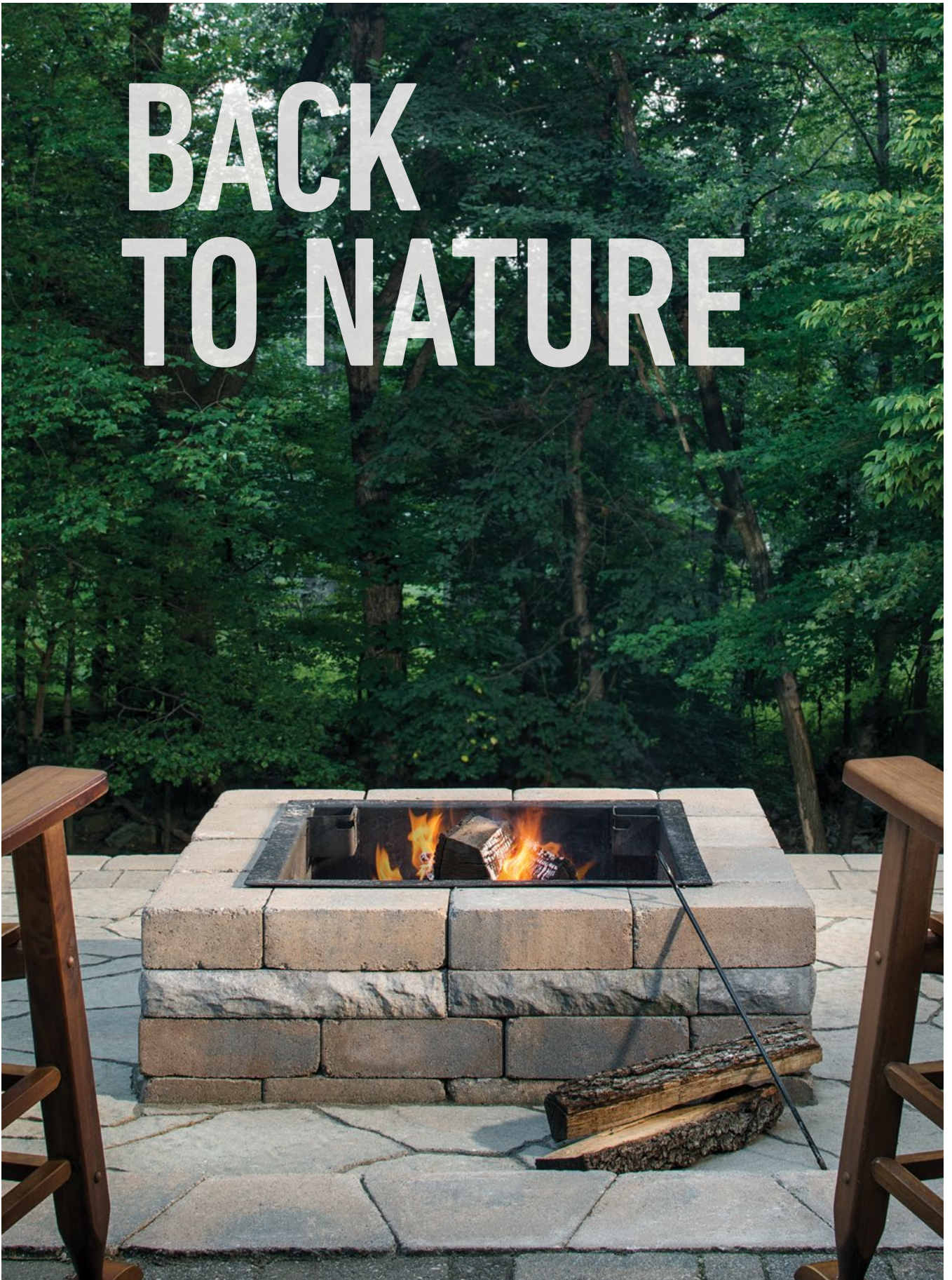

STYLISH ROOMSCAPES





DISPLAY YOUR VIEW. NO FRAME REQUIRED.

Pictured: Mega-Arbel Patio Slab



STAY INSPIRED.
SEE MORE ROOMSCAPES
@ PINTEREST.COM/BELGARD

LIVE WITHOUT BOUNDARIES

Outdoor settings become rooms without roofs – no longer just dining areas on decks. Create outdoor social spaces to entertain, work, play and relax.

Pictured: Holland Stone



FINE DINING ONLY A FEW STEPS AWAY

Pictured: Weston Stone

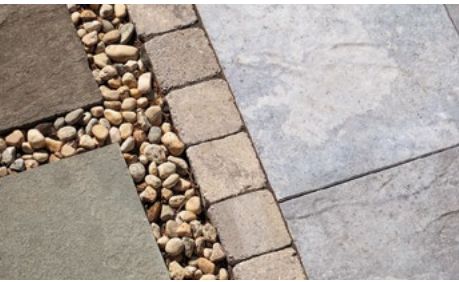

With dozens of styles, colors, shapes and textures to choose from, Belgard® products help you create outdoor living spaces that become an outward expression of your personal sense of style.

STYLE MADE SIMPLE

BAYOU BLEND



CRAB ORCHARD



DANVILLE BEIGE

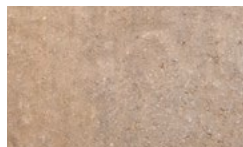
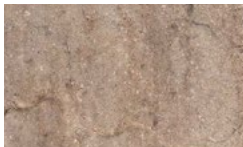

FOSSIL BEIGE



HILL COUNTRY

SLATE/RUSTIC



SCULPTED



COBBLED



DIMPLED



SMOOTH/GRANA

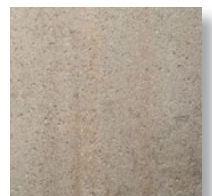

COLORS

LUEDERS GRAY

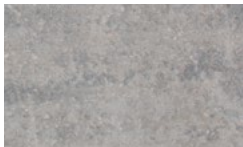

GRAY

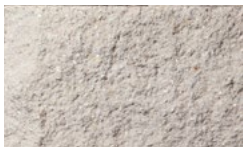

LLANO BLEND



TAN

TEXTURES

TRENDING & TIMELESS TIP

GO 'GREIGE'

The year's most sought after neutral isn't going out of style any time soon. Its beauty is in its versatility. The addition of gray to beige creates a richer hue that can work in a cool or warm color scheme, meaning your hardscapes will continue to coordinate with evolving styles.



STANDARD



DISTRESSED

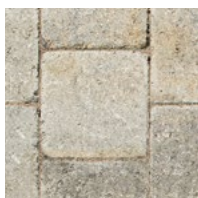

TUMBLED

SCALE



4" X 8"
HOLLAND STONE

15³/₁₆" X 20¹/₁₆"
MEGA-ARBEL®



12" X 3"
MODULINE SERIES®

5" X 11¹³/₁₆"
AGILINA™ PLANK



6" X 9"
CATALINA®



Old York



PROVIDE
VERTICAL
INTEREST

 **STAY INSPIRED.**
SEE MORE BORDER INSPIRATION
@ PINTEREST.COM/BELGARD



DEFINE YOUR SPACE

Incorporating multiple styles is a great way to segment your outdoor living areas into rooms without roofs. Adding a sleek border with a more natural stone, like in the image at right, creates the cozy feeling of a hearth rug in front of the fireplace.

Pictured: Lafitt Paver, Holland Stone (border) and Mega-Arbel Patio Slab (hearth rug)



CREATE A
WARM WELCOME

BREAK FROM THE NORM

Pictured: Lafitt Rustic Slab and Holland Stone (borders & banding)



MIX TEXTURES

From sleek contemporary to the look of cut slate Belgard offers a variety of textures to play with. Go for a monochrome look, like in the image at right, to maximize the tactile experience without overwhelming the eye.

Pictured: Lafitt Grana, Mega-Arbel Patio Slab (walkway)



ADD ACCENTS TO MAKE THE ORDINARY EXTRAORDINARY



BORDERS & BANDING

COLOR TECHNOLOGY

BRIGHTER COLORS, LONGER

Belgard® uses a variety of cutting edge technologies to improve product durability and make sure colors stand the test of time.

Through the use of proprietary admixtures and in-line treatments, Belgard is able to protect our product from the very beginning; during the manufacturing process.

PICTURED: CATALINA™ SLATE





TRUCCOLOR ENHANCES COLOR & DURABILITY

WHAT IS TRUCCOLOR?

Belgard's exclusive premium surface color-enhancing protectant. TrueColor enhances the original color depth of Belgard pavers and extends color fastness and durability over time. It also makes treated pavers more resistant to everyday wear and tear such as UV rays, stains and even acid. TrueColor is not a sealer, and does not create a glossy or wet look. It enhances the original color of the paver without losing the surface texture of real stone.

HOW IT WORKS

Surface texture has a lot to do with how our eyes perceive color. TrueColor works to fill in surface roughness, resulting in pavers with deeper, richer colors.

PROTECTION FROM FADING

Concrete fades when exposed to ultraviolet radiation from sunlight. TrueColor provides powerful UV protection that reduces fading – no more tired-looking pavers! In addition, everyday wear and tear effects the pigments in pavers. Over time, the fine particles containing pigment on the surface of the paver may be worn away leaving the paver looking faded. Pavers with high strength and low absorption will retain surface and color integrity over time. Integral color enrichment systems such as TrueColor can help to raise paver quality and preserve color depth and hues.



EXTENDS
DURABILITY



ENHANCES
COLOR DEPTH



PROTECTS FROM
UV RAYS



Old York Paver



Old York Paver with TrueColor

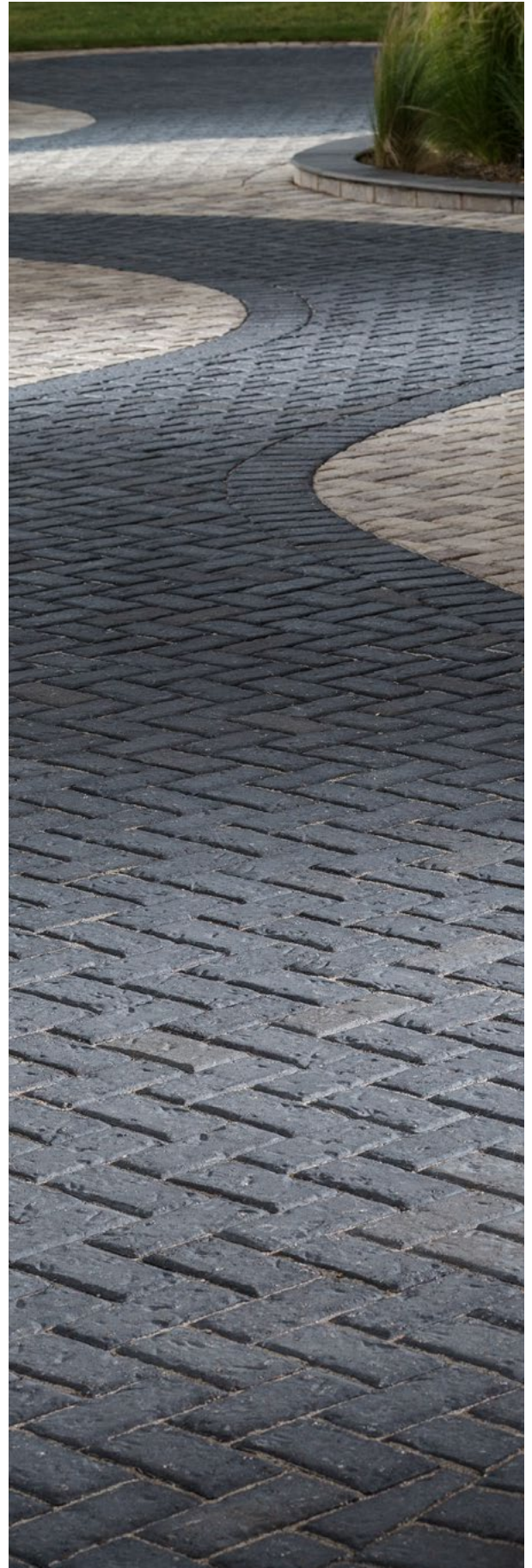



BUILD COLUMNS IN A SNAP

Tandem® Column Kit is an innovative, versatile system that can be used to create attractive, easy-to-install and durable columns. Great for use in residential and light commercial hardscape projects.

WALL IT OFF WITH U START

One of Belgard's latest innovations, U Start Base Block® is a universal base course for landscaping walls that promotes cost savings and installation time efficiency.

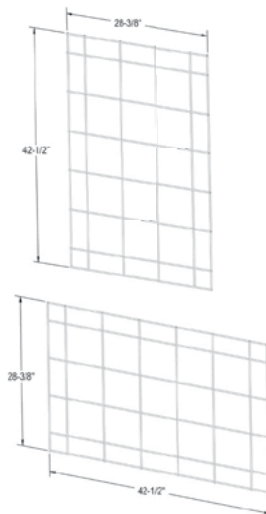
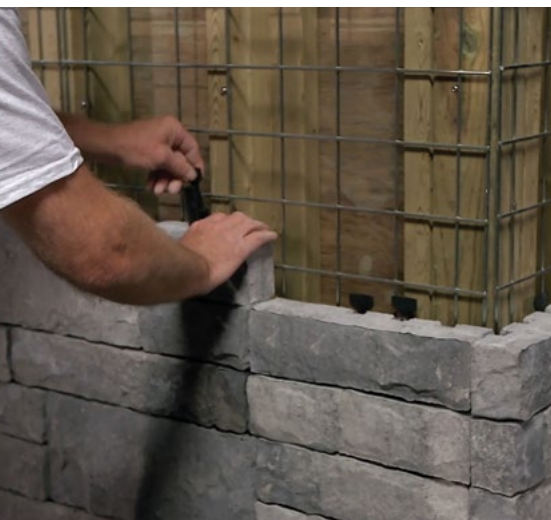
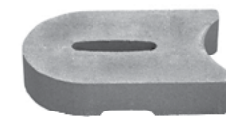

TANDEM® MODULAR GRID GIVES YOU ENDLESS POSSIBILITIES

Construct virtually any design up to 7' tall by simply attaching the grids to a wooden structure and connecting the veneers. Build an outdoor kitchen, skirt a deck, run electrical for lighting/sound, construct seat walls... the possibilities are endless.

INSTALLATION INNOVATIONS

PRODUCTS THAT MAKE INSTALLATION EASIER

Belgard® offers several products designed to make installation easier and more efficient. Why spend more time and money when you don't have to?

PICTURED: TANDEM COLUMN KIT



LET US
INSPIRE YOU.





Pictured: Urbana Stone, Bristol Fireplace & Wood Boxes

MAKE A SPLASH



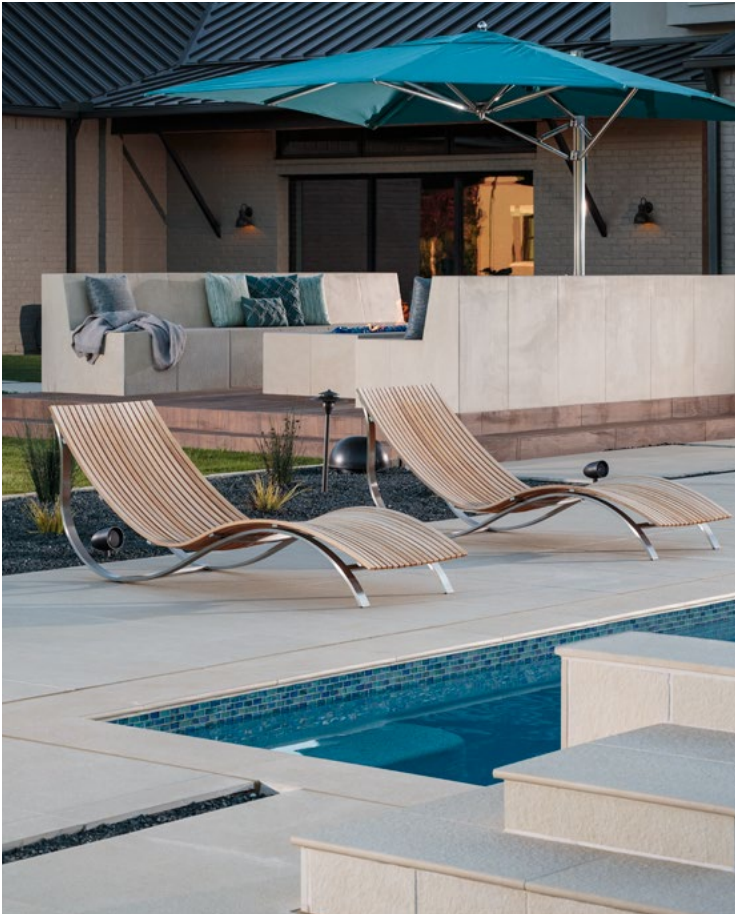

TOP
Turin Porcelain Pavers in Canyon

BOTTOM
Lafitt Rustic Slab in Danville Beige

OPPOSITE
Eco Dublin in Danville Beige

PAVERS COPING WALLS

Whether bringing new life to an old pool or installing a new one, Belgard® pavers and wall products can help you create stunning poolscapes that go beyond the water's edge to connect all of your outdoor spaces into one flowing design.

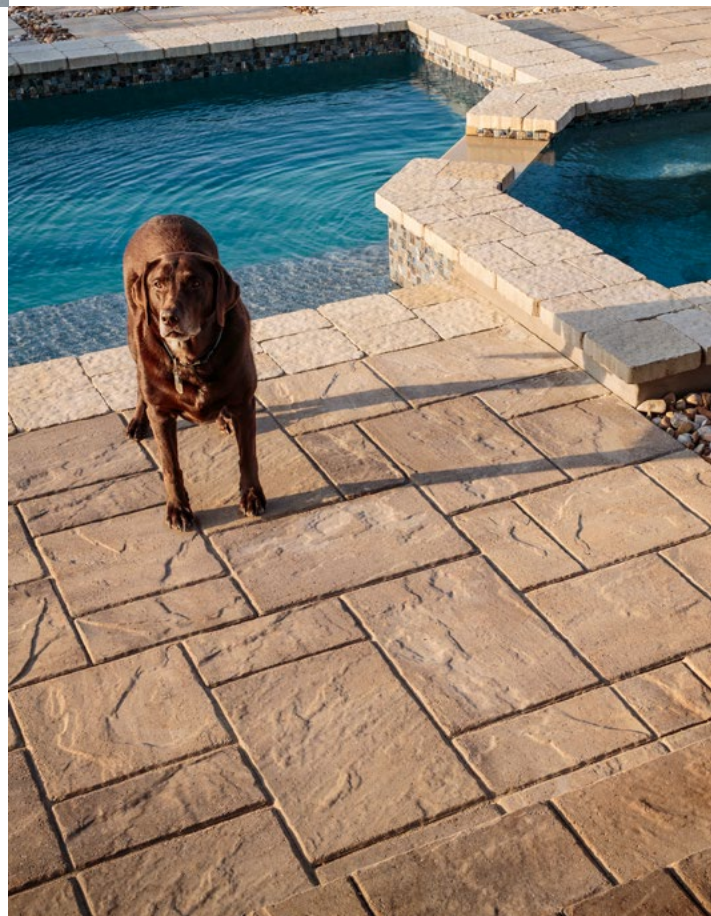



TOP
Holland Stone in Fossil Beige
Weston Stone Wall in Danville Beige

OPPOSITE
Turin Porcelain Pavers in Mountains
Unico Coping in Mountains



TOP
Bristol Series Brick Oven

BOTTOM
Weston Stone in Danville Beige
Weston Stone Fire Pit Kit

OPPOSITE
Lafitt Tandem in Danville Beige
Tandem Cap



COZY UP ENTERTAIN MAKE MEMORIES

With Belgard®, you can create outdoor living rooms that become the hub of activity for your family. Imagine roasting marshmallows over a crackling fire or cuddling up on a cool fall evening in front of the hearth. Now that's living.

CREATE A SPARK







TOP

Urbana Stone
Weston Stone in Danville Beige
Weston Stone Fire Pit Kit

OPPOSITE

Lafitt Rustic Slab in Lueders Gray

TAKE THE NEXT STEP





TOP

Lafitt Rustic Slab in Danville Beige
Weston Wall in Lueders Gray

BOTTOM

Weston Wall in Danville Beige
Dublin Cobble in Danville Beige
Holland Stone in Fossil Beige

OPPOSITE

Weston Wall in Danville Beige

INNOVATION
EXPERTISE
INSPIRATION

Our purpose is to make outside your kind of beautiful. This goes beyond turning creativity and craftsmanship into lasting outdoor spaces. It means bringing your vision to life, together. Because with Belgard® you get more than just beautiful products, you get a partner to help you every step of the way.

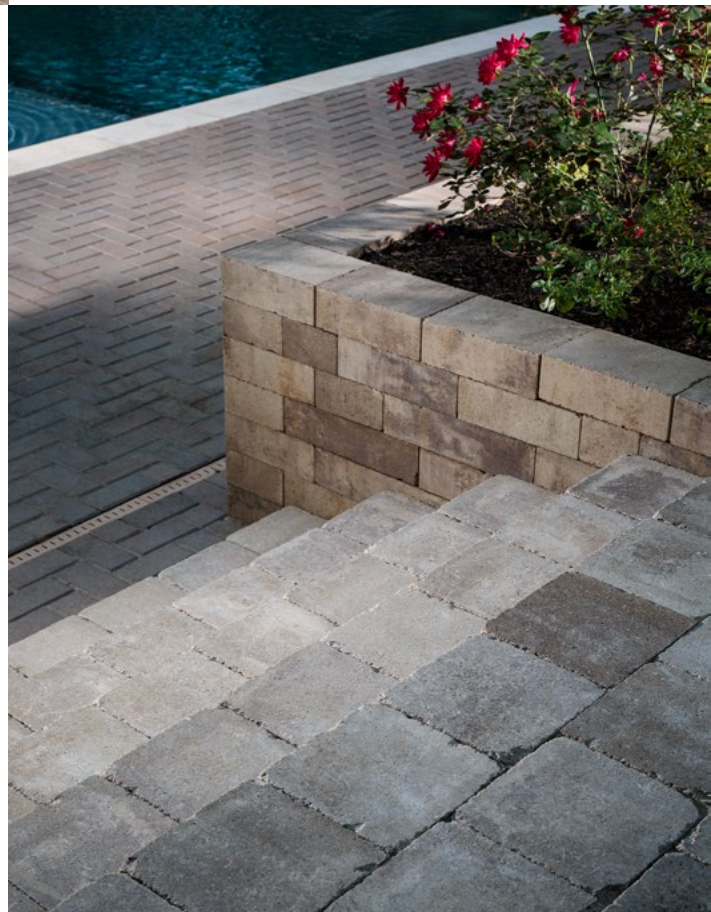



TOP
Mega Tandem Wall in Danville Beige
Landings Step

OPPOSITE
Lafitt Tandem in Danville Beige
Tandem Cap



TOP
Dublin Cobble in Danville Beige
Weston Stone in Danville Beige

BOTTOM
Eco Dublin in Fossil Beige

OPPOSITE
Weston Stone in Danville Beige

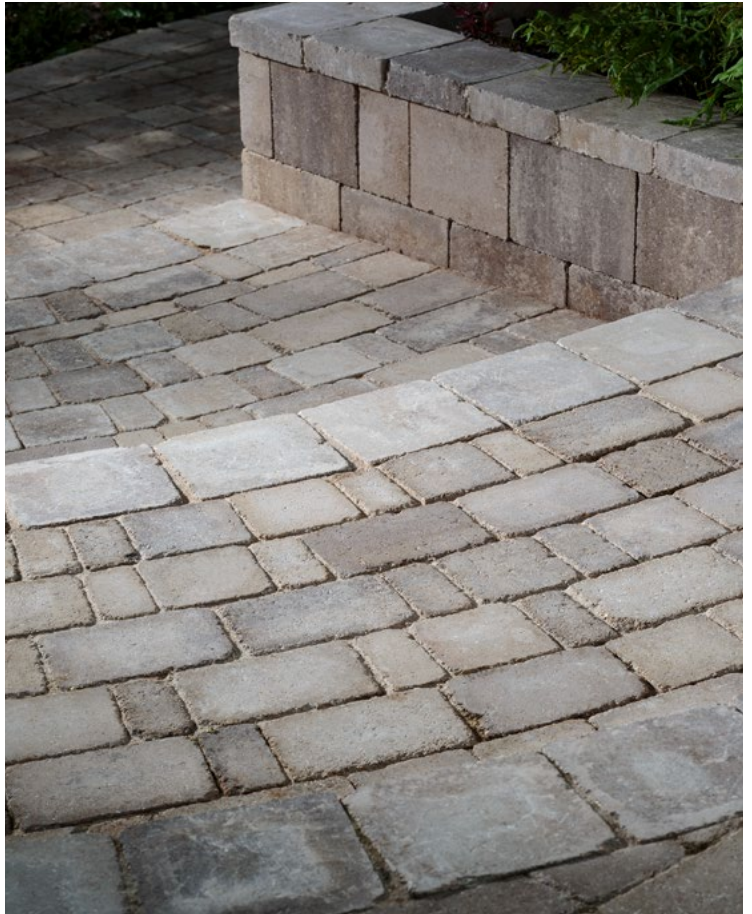

TIMELESS STYLISH QUALITY

Belgard® hardscapes elevate your outdoor living space to new heights with colors and styles that are both trending and timeless. Manufactured to last, and backed by our limited lifetime guarantee, your outdoor retreat is made to last.

SET IT IN STONE







TOP

Dublin Cobble in Danville Beige
Lamina Tandem in Danville Beige

OPPOSITE

Catalina Slate in Crab Orchard
Holland Stone in Charcoal (border)



PAVERS & SLABS

38
Cambridge Cobble®

NEW **40**
Catalina Grana® 

42
Catalina™ Slate 

44
Dublin Cobble®

46
Holland Stone

48
Lafitt® Grana Slab

50
Lafitt® Rustic Slab

51
Mega-Arbel®

NEW **52**
Melville™ Plank

PERMEABLE

54
Aqua Roc™ II 

56
Eco Dublin® 

PORCELAIN

58
Noon

NEW **60**
Turin

NEW **61**
Verona

62
Unico

LEGEND



WALKWAYS



PATIOS



POOLS



DRIVEWAYS



PERMEABLE



TRUECOLOR



PAVERS + SLABS

CLASSIC CONTEMPORARY STONE TEXTURE

Create eye-catching walkways, patios and driveways that express your personal sense of style. Belgard® pavers are strong, durable and environmentally friendly, helping you create beautiful spaces that will stand the test of time. You pick the look.

WE'LL PAVE THE WAY



Catalina Grana

OLD WORLD PAVER

CAMBRIDGE COBBLE®

PAVERS



The versatile Cambridge Cobble offers a tailored, architectural look with gently rounded corners and a domed pillowtop surface. The subtle color combinations and multiple pattern options make it ideal for crafting intricate designs.



AVAILABLE COLORS

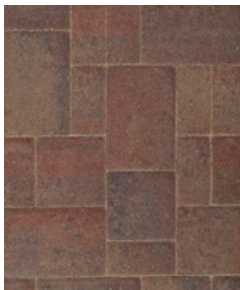

Brazos Blend



Danville Beige

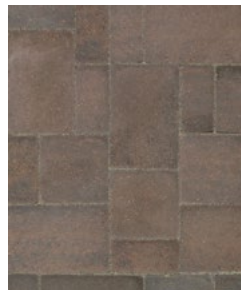

Fossil Beige

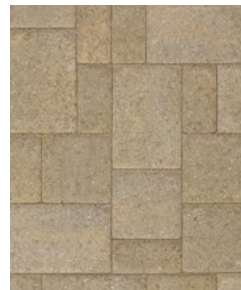

Hill Country

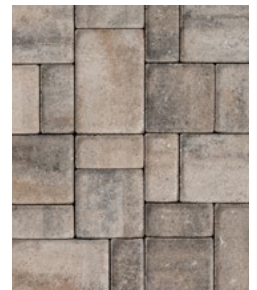

Lueders Gray

SHAPES & SIZES

3-Piece Modular



6 x 3 x 2 $\frac{3}{8}$



6 x 6 x 2 $\frac{3}{8}$

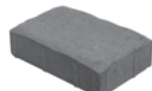

6 x 9 x 2 $\frac{3}{8}$

Commercial applications available. Contact your Belgard® representative for details.



NEW
CATALINA GRANA[®]
PAVERS WITH TRUCCOLOR[™]

Catalina Grana offers crisp, clean lines and a smooth, linear surface that creates an eye-catching contemporary look that's ideal for high-traffic areas.



AVAILABLE COLORS*

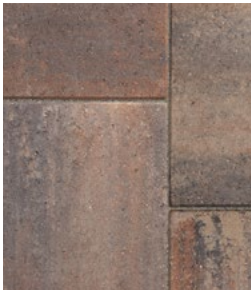

Crab Orchard

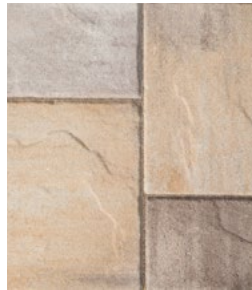

Danville Beige



Lueders Gray

TRUCCOLOR

TrueColor product enhancement technology is an exclusive and proprietary enhancer applied to Belgard[®] products during the manufacturing process. It penetrates deep into the product, rendering it resistant to stains and acid rain, protecting each unit from the wear and tear of everyday use while enriching paver colors. See page 14 for more information.



TRUCCOLOR[™]

SHAPES & SIZES

3-Piece Small



3 x 6 x 2³/₈



6 x 6 x 2³/₈



6 x 9 x 2³/₈

3-Piece Large



6 x 12 x 2³/₈

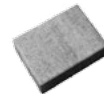

9 x 12 x 2³/₈

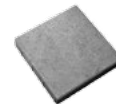

12 x 12 x 2³/₈

Commercial applications available. Contact your Belgard[®] representative for details.

*Swatches represent product color only, not surface texture, dimension and/or shape.



CATALINA™ SLATE

PAVERS WITH TRUCCOLOR™



Catalina Slate combines the flexibility of modular design with the textured finish of natural slate. The three-piece system is available in two sizes for increased design flexibility.



AVAILABLE COLORS



Crab Orchard

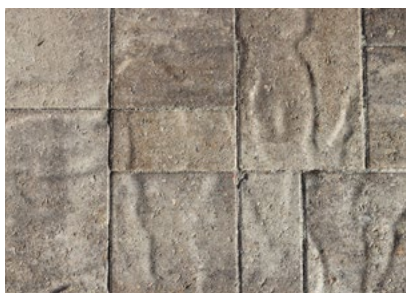

Danville Beige



Lueders Gray

SHAPES & SIZES

3-Piece Modular



3 x 6 x 2³/₈



6 x 6 x 2³/₈

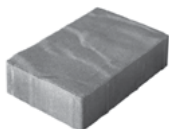

9 x 6 x 2³/₈

3-Piece Stone

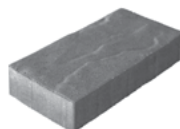

6 x 12 x 2³/₈

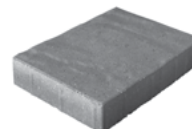

9 x 12 x 2³/₈

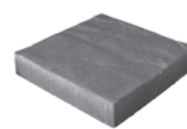

12 x 12 x 2³/₈



DUBLIN COBBLE®

PAVERS



A true classic, the gently distressed surface and antiqued edging of Dublin Cobble creates a casually elegant, time-worn look.



AVAILABLE COLORS



Danville Beige



Fossil Beige

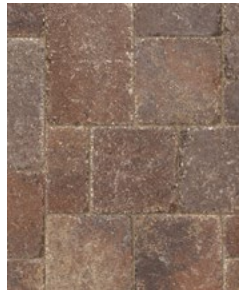

Harvest Blend



Hill Country

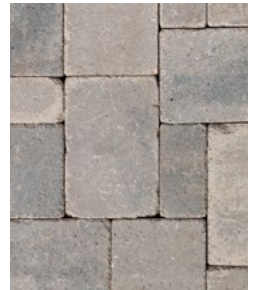

Lueders Gray

SHAPES & SIZES

3-Piece Modular



3 x 6 x 2 3/8

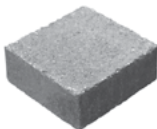

6 x 6 x 2 3/8

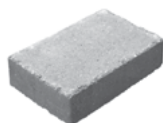

9 x 6 x 2 3/8

Large Square

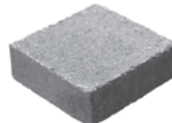

9 x 9 x 2 3/8

Commercial applications available.
Contact your Belgard® representative for details.



HOLLAND STONE

PAVERS



The classic shape, smooth surface and multiple color options make Holland Stone ideal for creating a wide variety of traditional looks. Holland Stone is also an excellent choice as a border element.

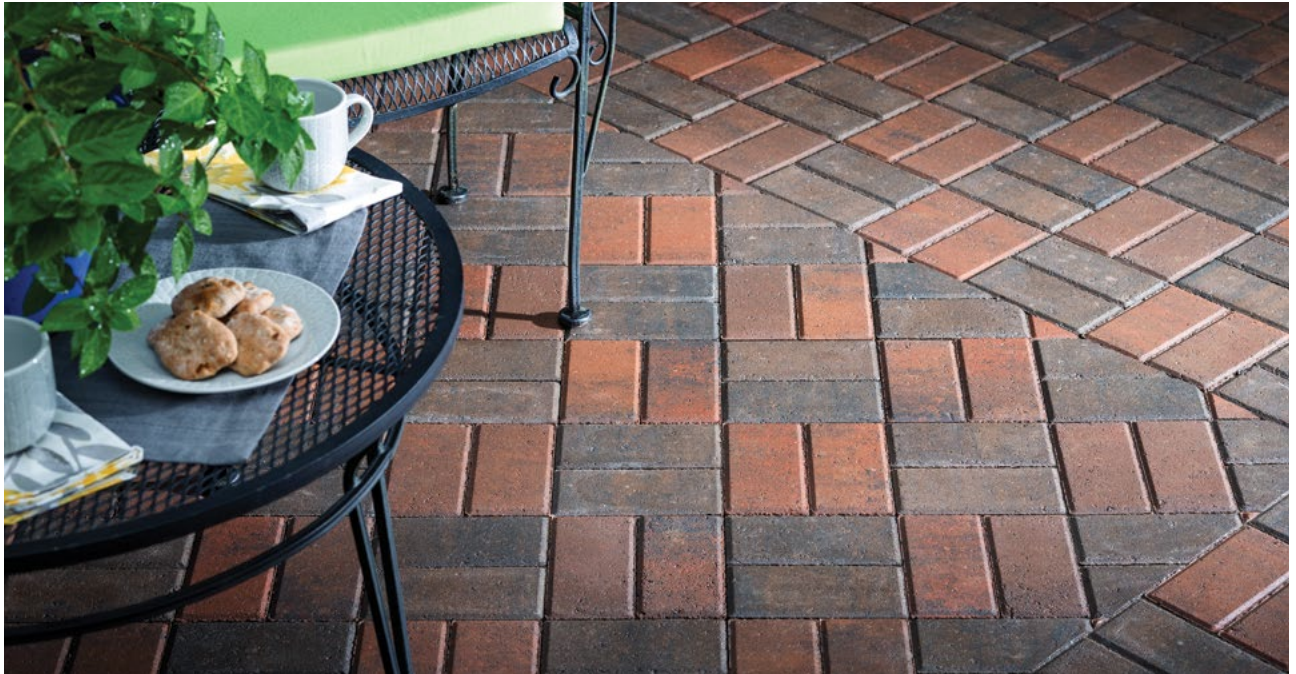

AVAILABLE COLORS



Brazos Blend



Charcoal

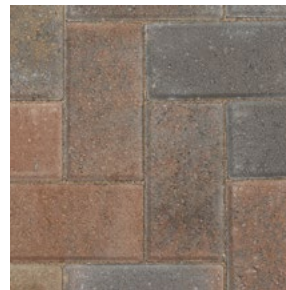

Fossil Beige



Red/Charcoal Flash

SHAPES & SIZES

60mm Holland Stone



4 x 8 x 2 $\frac{3}{8}$

Commercial applications available.
Contact your Belgard® representative for details.



LAFITT® GRANA SLAB

PATIO SLABS



Lafitt Grana Slab is an updated look on Belgard's popular Lafitt® Rustic Slab. This elegant product incorporates a modular three-piece system with a smooth finish to give homeowners a simple modern elegance. These pavers create beautiful patios and walkways that are barefoot friendly.



AVAILABLE COLORS*

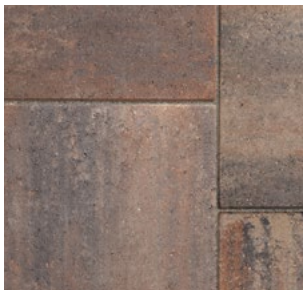

Crab Orchard



Danville Beige

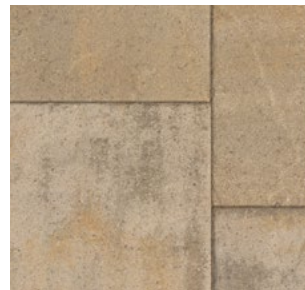

Hill Country



Lueders Gray

SHAPES & SIZES

3-Piece Modular



14⁷/₈ x 7³/₈ x 2

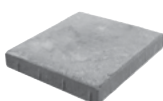

14⁷/₈ x 14⁷/₈ x 2

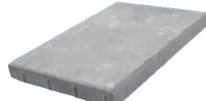

14⁷/₈ x 22¹/₆ x 2



LAFITT® RUSTIC SLAB

PATIO SLABS



Lafitt Rustic Slab features the look and texture of cut slate paired with the versatility of larger-scale modular design. It also offers the option to overlay onto existing concrete, depending on site conditions.



AVAILABLE COLORS*

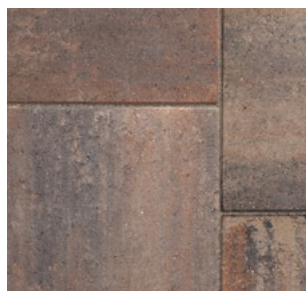

Crab Orchard

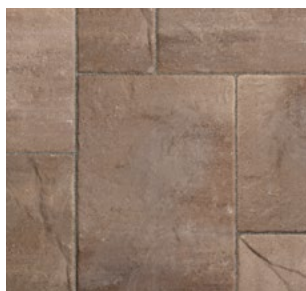

Danville Beige



Hill Country

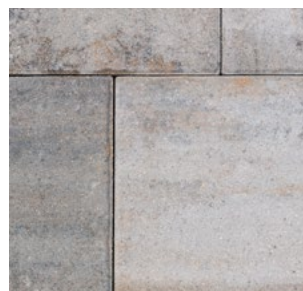

Lueders Gray

SHAPES & SIZES

3-Piece Modular

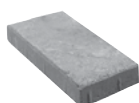

14⁷/₈ x 7³/₈ x 2

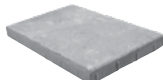

14⁷/₈ x 14⁷/₈ x 2

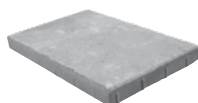

14⁷/₈ x 22⁷/₁₆ x 2

MEGA-ARBEL®

PAVERS



Mega-Arbel offers the look and feel of natural flagstone. With an irregular shape and false joints, it creates a random look that flows harmoniously into the surrounding landscape.



AVAILABLE COLORS



Crab Orchard



Danville Beige

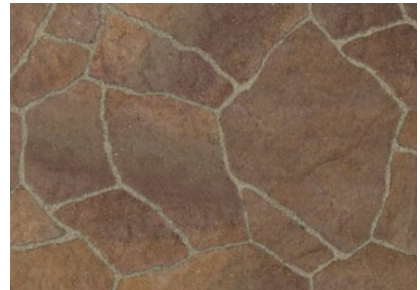

Oklahoma Flagstone

SHAPES & SIZES

Mega-Arbel 60mm

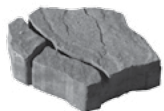

15³/₈ x 21 x 2³/₈

NEW MELVILLE™ PLANK

PAVERS



Melville Plank offers a smooth face and clean lines to create a stylish, contemporary look with classic appeal. It can be used alone, or added as an accent or border to a variety of paver designs.



AVAILABLE COLORS*

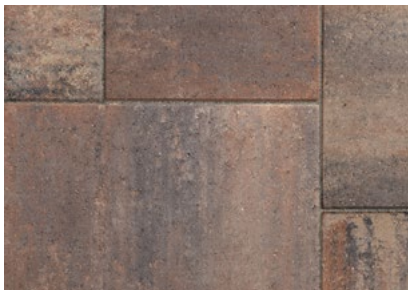

Crab Orchard

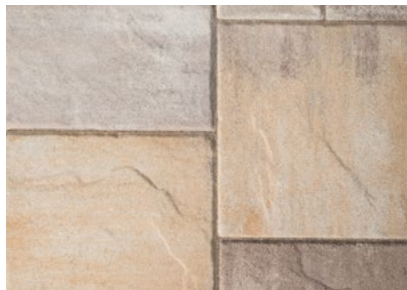

Danville Beige



Lueders Gray

SHAPES & SIZES

3-Piece Slim



2 $\frac{1}{8}$ x 5 x 11 $\frac{13}{16}$



2 $\frac{1}{8}$ x 5 x 15 $\frac{3}{4}$



2 $\frac{1}{8}$ x 5 x 19 $\frac{11}{16}$

3-Piece Large



2 $\frac{1}{8}$ x 7 $\frac{1}{2}$ x 11 $\frac{13}{16}$



2 $\frac{1}{8}$ x 7 $\frac{1}{2}$ x 15 $\frac{3}{4}$



2 $\frac{1}{8}$ x 7 $\frac{1}{2}$ x 19 $\frac{11}{16}$



AQUA ROC™ II

PERMEABLE PAVERS



With classic appeal, Aqua Roc II offers a green solution for those who love the look of a traditional paver. Able to support heavy vehicular loads, Aqua Roc II is an excellent choice for a variety of residential needs.



SHAPES & SIZES

Large Unit

Half-Size unit

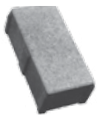

$3\frac{15}{16} \times 7\frac{7}{8} \times 3\frac{1}{8}$

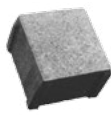

$3\frac{15}{16} \times 3\frac{15}{16} \times 3\frac{1}{8}$

Both sizes on one pallet

Commercial applications available. Contact your Belgard® representative for details.

Contact your Belgard sales representative for color options.



ECO DUBLIN®

PERMEABLE PAVERS



Eco Dublin provides an environmental solution with the contemporary modular look of cut stone, which pairs well with nearly any architectural style.



AVAILABLE COLORS



Danville Beige

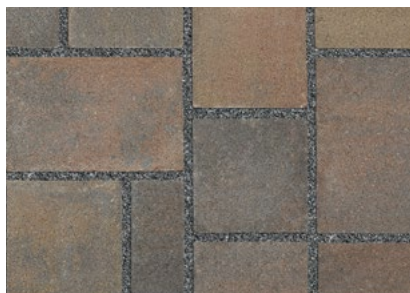

Fossil Beige



Lueders Gray

SHAPES & SIZES

3-Piece Modular



6 7/8 x 3 7/16 x 3 1/8



6 7/8 x 6 7/8 x 3 1/8



6 7/8 x 10 1/4 x 3 1/8

Commercial applications available. Contact your Belgard® representative for details.



NOON

WOOD FINISH PORCELAIN PAVERS



Warm and bursting with light, Noon is a contemporary expression of the simple life. The collection combines the warmth of natural wood with the elegance of glossy wood, incorporating all the extraordinary technical characteristics of porcelain stoneware: timeless and fearless.



AVAILABLE COLORS

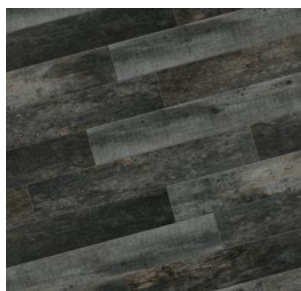

Charcoal
NN 05 ST - V4

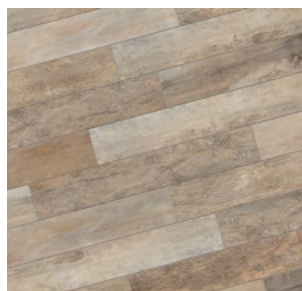

Daylight
NN 01 ST - V4

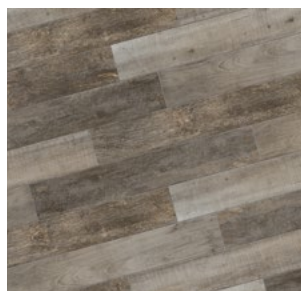

Ember
NN 02 ST - V3

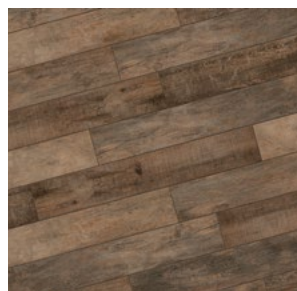

Honey
NN 03 ST - V3

SHAPES & SIZES

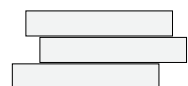

7.80 x 47.17 x 3/4



11.73 x 47.17 x 3/4



Spacers are recommended for all porcelain paver installations. PLEASE NOTE: For vehicular applications, there must be a mortar install over a concrete slab.



NEW TURIN

STONE FINISH PORCELAIN PAVERS



Turin porcelain pavers closely mimic the subtle textures and muted iridescence of natural unpolished quartz to create stunning contemporary outdoor living spaces and poolscapes.



AVAILABLE COLORS



Frost - V3



Canyon - V3



Rapids - V3



Stream - V3

SHAPES & SIZES

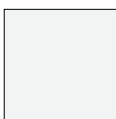

24 x 24"

NOTE: This product can be installed using elevated systems.



Spacers are recommended for all porcelain paver installations. PLEASE NOTE: For vehicular applications, must be a mortar install over a concrete slab.

NEW VERONA

STONE FINISH PORCELAIN PAVERS



The Verona line emulates a variety of natural stones to create distinctive outdoor living designs. Each available color was fashioned to closely mimic the specific natural qualities of a different quarried stone.



AVAILABLE COLORS*



Blue Stone – V3



Taos – V3



Yukon – V4



Platinum – V3

SHAPES & SIZES



24 x 24"

NOTE: This product can be installed using elevated systems.



Spacers are recommended for all porcelain paver installations. PLEASE NOTE: For vehicular applications, must be a mortar install over a concrete slab.

SPECIAL ORDER UNICO

PORCELAIN STEP AND COPING



Two installation needs, a single solution. This versatile porcelain unit is processed on both sides to give you maximum flexibility and design freedom.

Unico can be used as a step and as a coping for swimming pools. With a rounded, bullnose edge or straight edge, this uniquely functional border piece looks great from every angle.



SIZE

12.99 x 23.54 x 3/4
Double sided special trim



ROUNDED EDGE



STRAIGHT EDGE

AVAILABLE COLORS

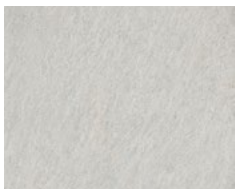

Quarziti 2.0
Glacier
QR 01 NAT



Quarziti 2.0
Mountains
QR 02 NAT

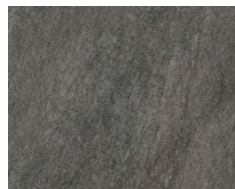

Quarziti 2.0
River
QR 04 NAT

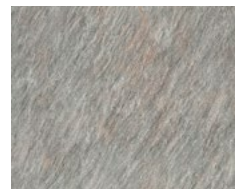

Quarziti 2.0
Waterfall
QR 03 NAT

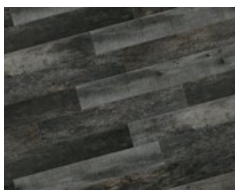

Noon
Charcoal
NN 05 ST

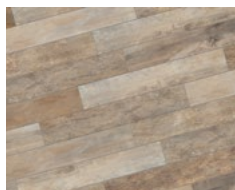

Noon
Daylight
NN 01 ST

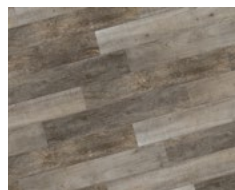

Noon
Ember
NN 02 ST

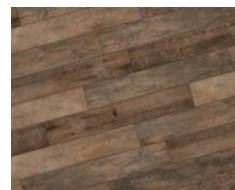

Noon
Honey
NN 03 ST



SCULPTED

70
Lafitt Tandem™

71
Lamina Tandem™

STANDARD

72
Diamond® 9D

NEW **74**
Diamond® 9D 2.0

NEW **76**
Diamond® 9D 2.0
Column Kit

78
Landings™ Step Unit

79
Coventina Coping

80
Weston Stone™

PRO

82
Diamond Pro®

83
Diamond Pro® PS

84
Diamond Pro Stone Cut®

Weston Stone

LEGEND



STEPS



WALLS



FIRE PITS



KITCHENS



COLUMNS



WALLS

SCULPTED STANDARD or PRO

Whatever the building requirement, Belgard® wall systems are designed to work in harmony with your landscape. From functional retaining walls to fashionable outdoor living areas, you decide the application.

WE'LL PAVE THE WAY

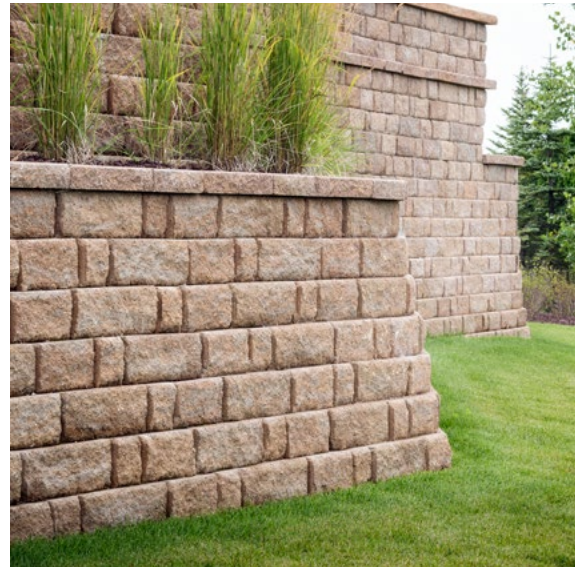

Diamond® 9D

FREESTANDING OR RETAINING

Knowing the difference between retaining and freestanding walls can have a positive impact on your project and lead to a more enjoyable outdoor space.

Freestanding walls allow you to divide your outdoor living space into different areas. They provide visual interest and can make even the largest yard feel more intimate. Freestanding walls easily incorporate with other features like fireplaces or outdoor kitchens to provide a cohesive look.

Retaining walls can have multiple purposes. Some help to increase usable space, whether that be a flower bed or added yard space, while other retaining walls help to prevent erosion. Either application is made possible by a wall system that holds back soil and properly manages drainage. Larger walls also utilize soil reinforcement for added strength and long-term stability.

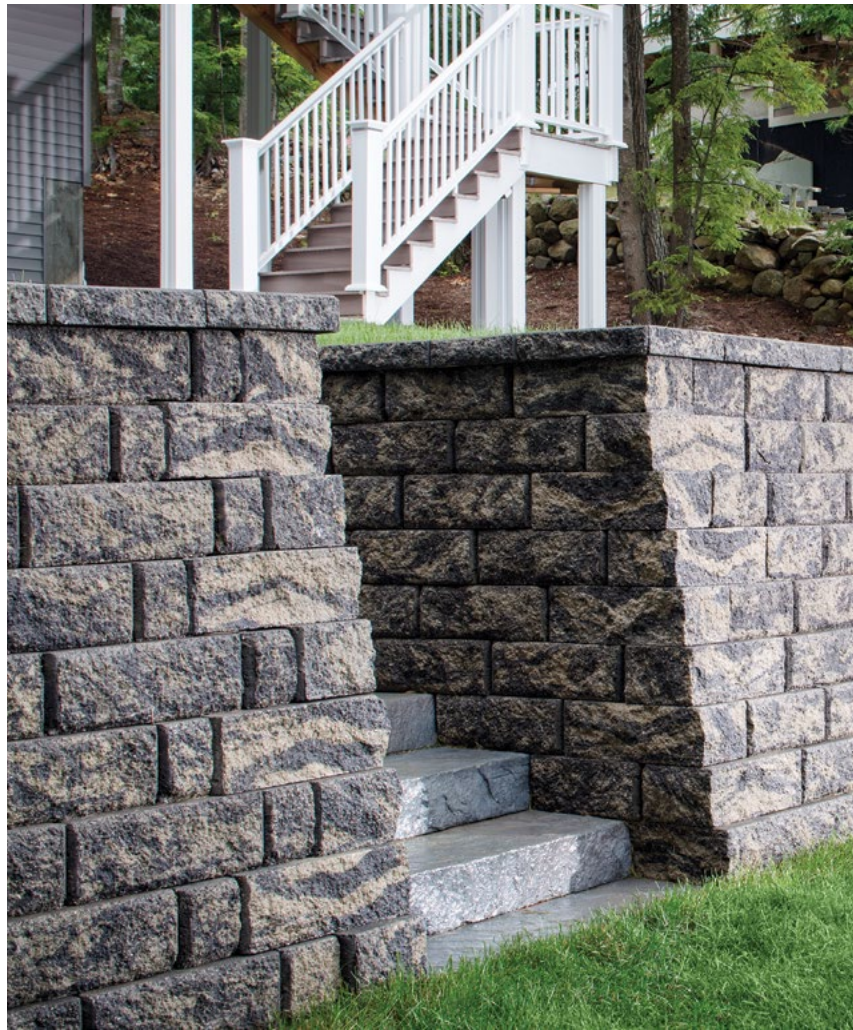

ACCESSORIES

The details complete the design. Belgard offers caps, columns and other accessories to complement any hardscape design. Mix textures to add a modern look to a rough-hewn wall-face. Include a cap in a complementing color to add visual interest. The possibilities are endless!

Consult a Belgard Certified contractor for information on all of our wall products and to receive project design assistance through Belgard Design Studio.



HOW TO SHOP WALLS

FACE-STYLES

Outdoor areas of any size or shape can be transformed with Belgard wall products. The shapes and textures of our wall systems blend with the environment to create attractive and functional landscape wall features.



STRAIGHT
CRISP, CLEAN LINES



VIRTUAL JOINT
*MULTI-PIECE LOOK WITH
THE INSTALLATION SPEED
OF A SINGLE-PIECE SYSTEM*



BEVELED
*TRADITIONAL LOOK
WITH AN ANGLED PLANE*



VICTORIAN
*CLASSIC ELEGANCE
WITH A STRAIGHT
BEVELED FACE*



STONE CUT
*ROUNDED AND
ROUGH-HEWN*



Tandem® Wall

The Tandem family of products is a revolutionary platform that showcases the Stone-like aesthetic that homeowners prefer while offering job site efficiencies contractors need. Tandem is a complete system, with a column kit and modular grid to provide versatility and 2 face styles to complement any outdoor living space.





COLUMNS

Building columns is easy with the Tandem system. Add a finishing touch to a wall, create a grand entry the end of a driveway or dress-up an existing deck post. Ask your Belgard® Representative about our Tandem® Column Kit with Steel Cages, Clips and Veneer Units in one convenient package.



MODULAR GRID

Tandem® Modular Grid is a revolutionary system that makes it easy to construct outdoor living elements. Use steel grids and heavy-duty connectors to construct virtually any structure up to 7 ft tall including privacy walls, outdoor benches, kitchens and much more.



WALLS

The Tandem Wall system designed by Belgard is an innovative, versatile system that can be used to create attractive, curved or straight retaining and freestanding landscape walls. Great for use in a wide range of residential and light commercial hardscape projects.

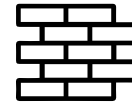

2 UNIQUE FACE STYLES



LAFITT TANDEM™
A solid unit with the look of chiseled stone



LAMINA TANDEM™
A Z-Shaped unit with the look of stacked stone



HOW IT WORKS

Belgard's connector design creates structural integrity in curved or straight walls.

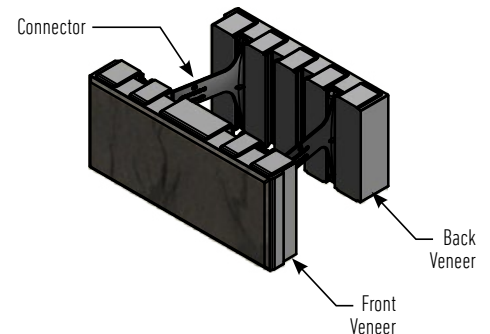

LAFITT TANDEM™

FREESTANDING / RETAINING WALLS



Lafitt Tandem features the look of chiseled stone and is ideal for an array of landscaping uses, including grade changes and freestanding walls. Available in solid or virtual joint units, to create a custom pattern.



AVAILABLE COLORS*



Crab Orchard

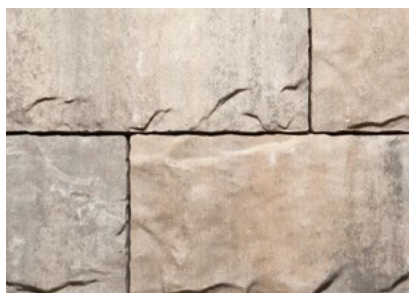

Danville Beige

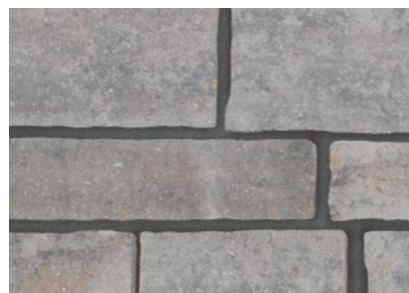

Lueders Gray

SHAPES & SIZES

Unit 1

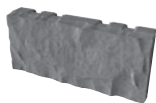

7 x 13³/₁₆ x 2⁵/₈

Unit 2

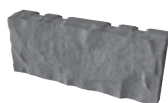

7 x 15¹/₁₆ x 2⁵/₈

Unit 3

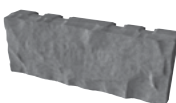

7 x 18⁷/₁₆ x 2⁵/₈

Cap Unit



3¹/₄ x 24 x 15

U Start Base Block

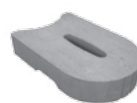

12 x 18⁷/₁₆ x 3¹/₂

8" Connecting Member

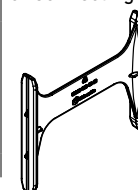

LAMINA TANDEM™ WALL

FREESTANDING / RETAINING WALLS



Lamina Tandem provides the look and feel of natural stacked stone with the versatility of installation options from the Tandem® Wall platform. Create beautiful freestanding walls, retaining walls and outdoor entertaining features with Lamina Tandem.



AVAILABLE COLORS*



Crab Orchard



Danville Beige



Lueders Gray

SHAPES & SIZES

Unit 1



7 x 15¹³/₁₆ x 2⁵/₈

Unit 2



7 x 18⁷/₁₆ x 2⁵/₈

Unit 3



7 x 21¹/₈ x 2⁵/₈

Cap Unit



3¹/₄ x 24 x 15

U Start Base Block

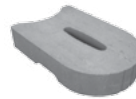

12 x 18⁷/₁₆ x 3¹/₂

8" Connecting Member

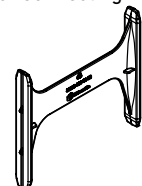

*Swatches represent product color only, not surface texture, dimension and/or shape.

DIAMOND® 9D

RETAINING WALLS



The rough-hewn distressed look and easy installation system have made Diamond 9D a favorite for residential wall projects. The system is topped with a coordinating cap unit.



AVAILABLE COLORS*



Bayou Blend

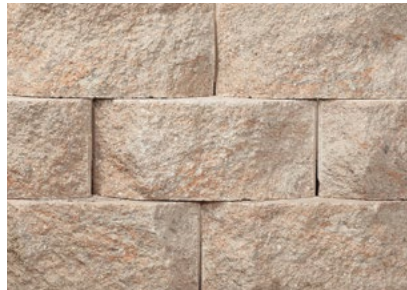

Llano Blend



Lueders Gray

SHAPES & SIZES

9D Multi-Piece



6 x 5⁷/₈ x 9



6 x 11⁷/₈ x 9

9D Block



6 x 17³/₄ x 9

Cap



3 x 16 x 9

Wall Innovations By



*Swatches represent product color only, not surface texture, dimension and/or shape.



NEW DIAMOND® 9D 2.0 FREESTANDING WALLS

With a rough-hewn face and multiple sizes, Diamond 9D 2.0 offers the look of a charming hand-stacked wall and can be used to create planters, raised patios, columns and more.

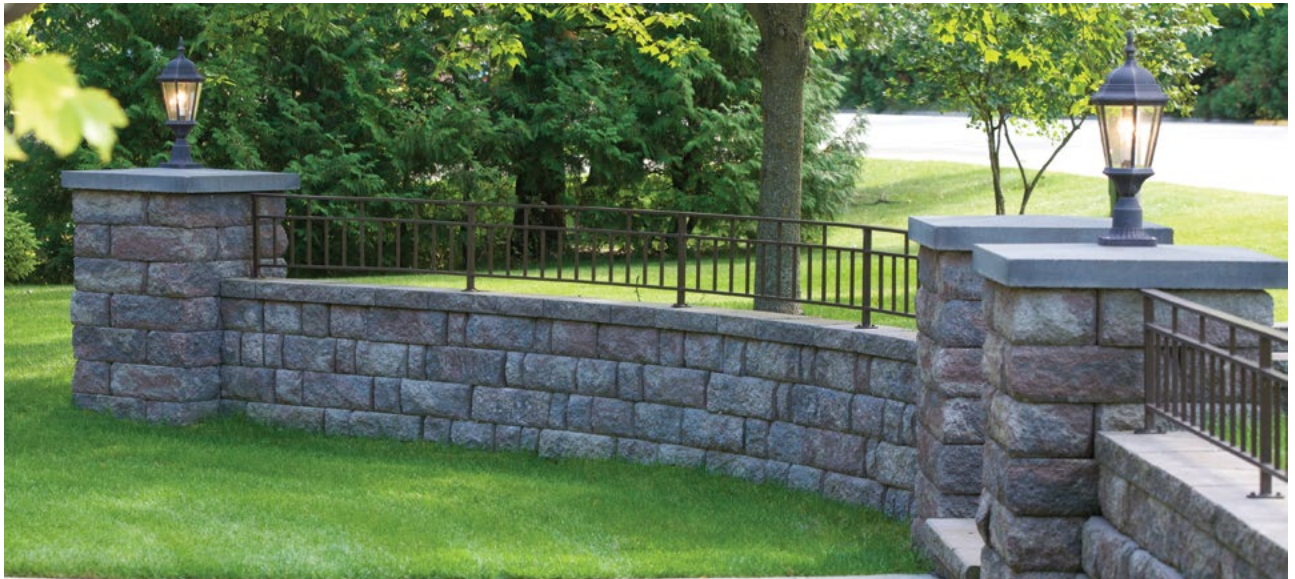

AVAILABLE COLORS



Bayou Blend



Llano Blend



Lueders Gray

SHAPES & SIZES

Small Block



6 x 6 x 5

Medium Block



6 x 12 x 5

Large Block

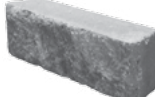

6 x 18 x 5

Column/Corner Unit



6 x 16 x 5

XL® Cap

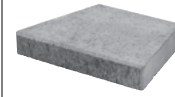

Front: 3 x 18 x 13
Back: 3 x 12 x 13

U Start Base Block

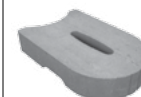

3 x 18 x 13

Wall Innovations By





NEW DIAMOND® 9D 2.0

ADAPTABLE COLUMN/CORNER KIT

Diamond® 9D 2.0 Columns are exceptional features to add to any landscape from flanking a freestanding wall to creating standalone elements. With one unit, create three different size columns.



SHAPES & SIZES

Column/Corner Unit

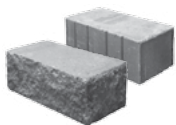

6 x 16 x 5

XL® Cap



Front: 3 x 18 x 13
Back: 3 x 12 x 13

U Start Base Block

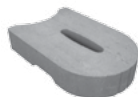

3 x 18 x 13

Wall Innovations By





LANDINGS™ STEP UNIT

STEPS



Double-sided texture and two unique faces on the rise allow steps to be rotated for optimal aesthetics.



AVAILABLE COLORS*



Desert Sand

SHAPES & SIZES

Landings Step



6 x 48 x 18

Wall Innovations By



*Also available in Crab Orchard and Lueders Gray

COVENTINA™

COPING/CAP



Coventina Coping features a textured surface and rich color blends that mimic the look and feel of natural cut slate. This versatile product complements a variety of paver styles and is not only the perfect finishing touch for linear and kidney-shaped pools, but can also be used to trim steps or cap a wall.



AVAILABLE COLORS*



Crab Orchard



Danville Beige



Lueders Gray

SHAPES & SIZES

Coping



3¾ x 7⅞ x 3⅝

*Swatches represent product color only, not surface texture, dimension and/or shape.

WESTON STONE™ & UNIVERSAL

FREESTANDING / RETAINING WALLS

The flexibility of Weston Stone is unmatched. With the look of natural tumbled stone, this double-sided wall is ideal for garden walls, pillars, outdoor kitchens, planters and fire features.



AVAILABLE COLORS*



Danville Beige



Gascony Tan

SHAPES & SIZES

3-Piece Combo



4 x 8 x 8



4 x 12 x 8

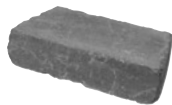

4 x 16 x 8

Universal



4 x 12 x 8

See page 89 for our
Weston Stone Fire Pit Kit



DIAMOND PRO[®]

RETAINING WALLS



Available in straight face, beveled face, or with virtual joints for a random look, Diamond Pro features the distressed look of Diamond and is the ideal choice for larger projects.



AVAILABLE COLORS



Fossil Beige



Gray



Lueders Gray



Tan

SHAPES & SIZES

Bevel Cut Unit

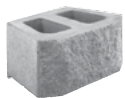

8 x 18 x 12

Cap



4 x 18 x 10½

Wall Innovations By



DIAMOND PRO[®] PS

RETAINING WALLS



Architects and engineers choose the Diamond Pro retaining wall system to create flexible, cost effective solutions for a broad range of large commercial, municipal and residential retaining wall projects.



AVAILABLE COLORS*



Fossil Beige



Gray



Lueders Gray



Tan

SHAPES & SIZES

Bevel Cut Unit

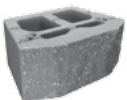

8 x 18 x 12

Victorian Cut Unit



8 x 18 x 12

Cap

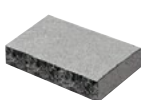

4 x 18 x 10½

Fiberglass Pins



5 L x 0.5

Wall Innovations By



*Swatches represent product color only, not surface texture, dimension and/or shape.

DIAMOND PRO STONE CUT®

RETAINING WALLS



Renowned for its rough-hewn face and earthen tones, the Diamond Pro Stone Cut retaining wall system imparts a rich, faceted appearance. It is the ideal choice for large scale wall projects.



AVAILABLE COLORS*



Fossil Beige



Gray



Lueders Gray



Tan

SHAPES & SIZES

Stone Cut Unit



8 x 18 x 12

Virtual Joint Left



8 x 18 x 12

Virtual Joint Right



8 x 18 x 12

Cap

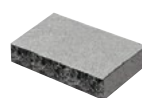

4 x 18 x 10½

Wall Innovations By





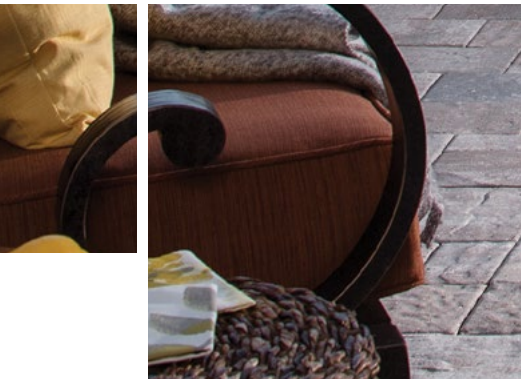

FIRE FEATURES

FIREPLACES OUTDOOR KITCHENS FIRE PITS

Outdoor focal points don't have to be a hassle. Our pre-assembled modular fireplaces and outdoor kitchens take the guesswork out of assembly and our fire pit kits make relaxation simple and installation easy. You cozy up.

WE'LL PAVE THE WAY



Weston Stone™ Fire Pit Kit

OUTDOOR FIRE FEATURES AND KITCHENS

Browse our outdoor kitchen collections and fireplace kits to find the right centerpiece for your al fresco experience. Our line of pre-assembled modular Elements™ not only carry our standard warranty, but also can be installed within hours to any project.



BRISTOL™ SERIES

A beautiful combination of tumbled block with Arbel® and Urbana® accents, Bristol's rustic look blends well with virtually any landscape.



BRIGHTON™ SERIES

Featuring the same 36" firebox as the Bristol Series, plus a built-in hearth and metal accent, Brighton is a beautiful option.



BORDEAUX™ SERIES

A timeless stackstone design that allows the fireplace, the grill island, or the brick oven to become the focal point of your outdoor space.



Shop Belgard Outdoor Kitchen and Fire Features at Belgard.com/Elements

BRICK OVENS

Inspired by traditional oven designs first used over four thousand years ago. The secret is our authentic, low-height Neapolitan dome design. The design creates high, even temperatures for balanced cooking and genuine wood-fired taste.

Available in Bordeaux™ and Bristol™ Series.

NOTE: All our Fireplaces, Brick Ovens, and Fire Pits come standard as wood-burning units. However, our fireplaces and fire pits can be retro-fitted for gas burning log sets and burners. Our brick ovens are wood burning units only. Please contact us for more details 877-235-4273. Also, be sure to check with your local municipality for any codes that may affect your installation.



Bristol™ Series Brick Oven



WESTON STONE™ FIRE PIT KIT

Belgard's Weston Stone™ Universal Fire Pit Kit installs quickly and offers the clean and contemporary look of tumbled stone. Available in four popular color blends developed to complement most Belgard paving stone and retaining wall types. Available in round or square kits.

BORDEAUX™ GRILL ISLAND

Featuring a Napoleon gas grill and stainless door set, Belgards' Bordeaux Grill Island will have you grilling in no time!



SPECIAL ORDER BORDEAUX™ SERIES

FIREPLACE

2'7"D x 4'3"W x 7'8"H

Our Bordeaux Series features a Lamina Stone for the body, and eye catching Cordova Stone Coping and Accents in either Midnight or Buff colors.



Fireplace Wood Boxes
2'1¼"D x 3'3"W x 3'1"H
per box
Sold as a pair.



Grill Island
2'6"D x 5'11"W x 3'5"H
Includes Napoleon Grill and Door Set. Grill is available in propane or natural gas. Must be specified when placing order.



Brick Oven
42½"D x 53¼"W x 92"H



SPECIAL ORDER BRIGHTON™ SERIES

FIREPLACE

3'4"D x 4'4"W x 8'4"H

Our Brighton Series features Weston Stone for the body, with Urbana Accents. It's available in either brown or gray tones. Includes wrought metal accent.



Fireplace Wood Boxes
2'4"D x 2'8"W x 2'11"H
per box
Sold as a pair.



Fireplace
3'4"D x 4'8"W x 8'4"H

SPECIAL ORDER BRISTOL™ SERIES

FIREPLACE
3'D x 5'W x 9'3"H

Our Bristol Series features Weston Stone for the body, with accents of Urbana and Mega Arbel. It's available in either brown or gray tones.



Fireplace Wood Boxes
2'4"D x 3'W x 3'3"H
per box
Sold as a pair.



Fireplace Hearth
2'D x 5'W x 11"H



Brick Oven
4'D x 4'W x 8'5"H



Grill Island
3'D x 6'4"W x 4'4"H
Includes Napoleon Grill and Door Set. Grill is available in propane or natural gas. Must be specified when placing order



PAVER CARE

PROTECT YOUR INVESTMENT

Belgard Products are designed to last for generations. Many homeowners choose to further protect and beautify their investment by applying a protective sealer. Adding a sealer can enhance the beauty of a project by highlighting the color and texture of the surface. It will also offer protection from stains like oil, grease or other accidental leaks.

Techniseal Protector for Concrete Pavers (Top-Bottom): Natural Look Matte Finish, Clear Look Semi-Gloss Finish, Color Boost Matte Finish, Wet Look Gloss Finish

THE ULTIMATE PROTECTION SYSTEM

Techniseal's 3-step treatment system guarantees the best results. Remove stains with a specially formulated Stain Remover, prepare the surface with Paver Prep, then apply a Protector that delivers the look you want.

1
PREP

STAIN REMOVERS



2
CLEAN

CLEANERS

- Dislodges efflorescence and ground-in dirt
- Prepares pavers prior to protector application
- Brightens paver color



3
PROTECT



SAME FINISHES,
HIGHER STANDARDS

Our versatile, new sealers have been formulated for easier product selection and application.



NULOOK®
TINTED PROTECTOR

- Colors pavers
- Translucent
- Water-based stain guard

DRiBOND™

CHANGING THE WAY YOU OVERLAY



BEFORE

AFTER

No More Concrete Removal!

With DriBond™, there is no need to remove the existing concrete substrate, which is a costly and time-consuming process. DriBond™ can be installed quickly and easily over most sound concrete surfaces.

- Ideal for thin paver overlays
- Dry application
- No mixing - ready to use
- Reduces installation time

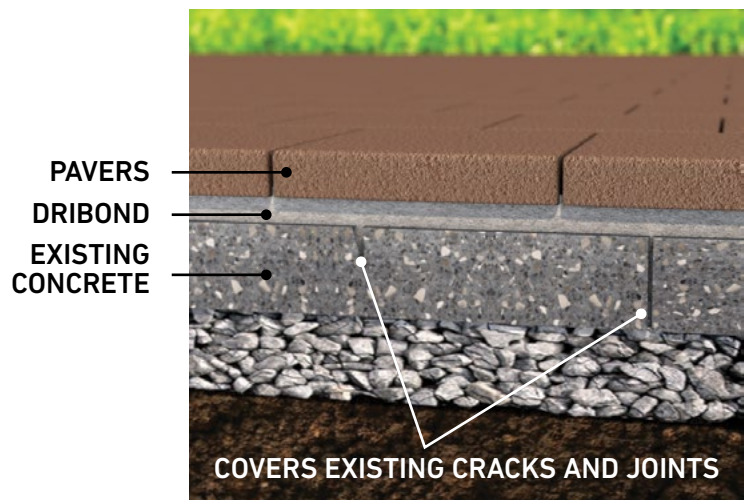

NO MESS. NO WASTE.



8 minutes
SET TIME

Easy to use

Yields
600
feet per can

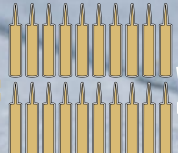
1 =  **20**

STRUCTUREBOND™ IS AN INNOVATIVE SUPER-STRENGTH FOAM ADHESIVE THAT BONDS A WIDE RANGE OF CONSTRUCTION MATERIALS.

Made from high-quality modified polyurethanes, StructureBond's adhesive strength is unmatched among all types of polyurethane adhesives.

StructureBond's Gun allows for a precise adhesive delivery with a single pull of the trigger. No pumping, cutting or puncturing of cartridge nozzles.

VISIT TECHNISEAL.COM FOR MORE DETAILS.



1 PREP

EZ BASE® PANEL BASE SYSTEM



- Saves up to 8 inches of excavation
- Each panel replaces up to 250 lbs of base aggregates
- Ideal for porcelain tile installation

PAVER EDGING

PREVENTS MOVEMENT & DAMAGE TO PAVER INSTALLATIONS

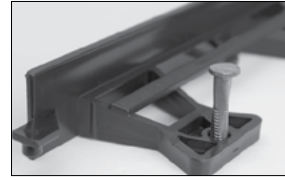

RIGID
8-FT SECTIONS

COIL
40-FT COIL

2 SET



STRUCTURE BOND™ FOAM ADHESIVE

- Application gun also included

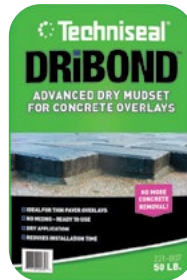

DRIBOND™ DRY MUDSET

- Applied directly to existing concrete slab
- Ideal for thin paver overlays



BORDERBOND™ FORTIFIER FOR BORDER PAVERS

- No Mixing required
- Enhances the strength of DRiBond

3 SAND



HP NEXTGEL™ JOINTING SAND

- High-performance formula
- For joints up to 4"
- Haze and dust free
- Super fast wetting
- Rapid set
- Prevents erosion and weeds



NEW SMARTSAND™ POLYMERIC SAND

WITH NEXTGEL TECHNOLOGY

- Ideal for interlocking pavers
- For joints up to 1"
- Easy sweep - No haze
- Fast wetting
- Rapid set
- Prevents erosion and weeds

SELECTING A CONTRACTOR



A hardscape project is an important investment in your home and selecting the right contractor is a critical decision. Don't be afraid to ask a lot of questions. It's important that you get to know your contractor so that you can work together as a team to create your ideal outdoor living space.

WHAT TO ASK

Are you certified?

Inquire about specialized certifications and training from organizations like the Interlocking Concrete Paver Institute (ICPI).

All Belgard® Contractors are required to have at least one team member who is ICPI certified and must meet annual requirements to maintain the company's status.

Are you insured?

It's important to hire a contractor who can provide proof of insurance and is able to guarantee their work for a period of at least three years after the installation.

Can I get a reference?

Ask for customer references and to see photos of past projects, both for design ideas and to get a sense of the contractor's level of creativity, expertise and work ethic. Ask for an address or two and check out the workmanship up close, with the homeowner's permission of course.

What isn't covered in your estimate?

Determine upfront which aspects of the project the contractor can handle. Will their team manage landscaping, plumbing, irrigation and lighting or will you be expected to handle this separately?

What's the schedule?

Be sure to get a complete understanding of payment terms, estimated start date and turn-around time.

CHECKLIST FOR CONTRACTOR:

- | | |
|--|---|
| <input type="checkbox"/> Industry Certification (ICPI, NCMA, SRW) | <input type="checkbox"/> Work Schedule |
| <input type="checkbox"/> Proof of Insurance | <input type="checkbox"/> Price Estimate |
| <input type="checkbox"/> Workmanship Guarantee (1-3 year minimum) | <input type="checkbox"/> Scope of Work/Contract |
| <input type="checkbox"/> Business License/ Contractor's license (where applicable) | <input type="checkbox"/> Referrals |



INSTALL WITH A BELGARD PREFERRED CONTRACTOR

Our network of Belgard Contractors are ICPI* trained to deliver superior craftsmanship. **Find a contractor or dealer:**

[Belgard.com/find-contractor](https://belgard.com/find-contractor)

DREAMS ON DEMAND

Step into your dream backyard before construction begins
with Belgard Design Studio



Belgard is your resource for outdoor living inspiration, planning and installation. From charming walkways and welcoming patios to gourmet outdoor kitchens – the possibilities are endless. Let us help you visualize a new outdoor space using virtual reality.

**REVIEW SAMPLE CONTENT, THEN REQUEST A CUSTOM DESIGN FOR YOUR HOME!
VISIT [BELGARD.COM/VR](https://www.belgard.com/vr)**

YOUR PROJECT STARTS HERE

Ready to take the next step?
Belgard provides tools to easily
kick off your next project



BELGARD® WILL IMPROVE THE BEAUTY AND VALUE OF YOUR HOME.

But like any construction project, it's necessary to have as much information as possible before you begin the process. With that in mind, we created a project planning guide dedicated to helping you make the best decisions and understand what to expect before you get started with your project.

GET YOUR PROJECT PLANNING GUIDE AT BELGARD.COM/PLANNER

PROJECT CONSIDERATIONS

- ❑ The general project should be conducted in phases, which include: demolition, site preparation, base material installation, bedding sand installation, hardscape installation, polymeric sand installation, additional paver cleaning and sealing.
- ❑ The timeline for your hardscaping project depends on several factors including the **size and scale** of the project, **permits needed** (which vary by municipality), and the acceptance of any community organizations, such as homeowner associations or architectural review boards.
- ❑ All outdoor projects are subject to weather conditions so there could always be delays.
- ❑ Spring and summer are the busiest periods for contractors, so **start your planning during the winter months** or consider scheduling your project in slower periods.
- ❑ **Confirm all the work you'd like done is contracted and scheduled up front.** Adding additional features will delay the schedule and add to the total cost.
- ❑ Check with your contractor to ensure that all items being installed are readily available or match your timeframe.
- ❑ Be sure to **discuss with your neighbors** any construction phases that might be disruptive so that you can communicate that information to them as needed.
- ❑ If you have a large project and would like to phase out construction over time, be sure to **plan the entire design** before you get started so that you can plan for any electrical, plumbing, drainage or landscaping needs.
- ❑ Consider building your backyard before any projects in the front yard to avoid damaging your front yard.
- ❑ When your project is finished, **walk through it with your contractor** to ensure the quality of the install, and **ensure you have receipts for materials / labor** and have registered your warranty.
- ❑ Always take into consideration the next step of the project: What does the landscaping look like? Do you need to schedule the contractor to seal the pavers? Plan ahead to make sure you finalize your project and can enjoy it for years to come.



TIMELINE -

Planning the project

PHASE 1: 4-6 weeks

- ❑ Consider how you will use the space and your budget
- ❑ Examine styles and colors for your house or landscape
- ❑ Get inspiration online
- ❑ Research approval requirements from municipality or HOA
- ❑ Set a budget

Installation

PHASE 3: 2-12 weeks

- ❑ Time of the installation will depend on the scope of the project
- ❑ Check with the contractor to ensure the materials ordered have the correct color and are accurate
- ❑ Connect with your contractor to ensure it is properly installed



MAKE YOUR DREAMS A REALITY

with Belgard Preferred Payment



With the Belgard® Preferred Payment program, you can complete your outdoor project in just a few weeks, instead of phasing it out over several months or years.

Available only through **Belgard Contractors or Dealers**, Preferred Payment offers same-as-cash financing that allows you to start your project immediately.

There are often construction economies that can be achieved by doing the entire project at once, **which could save you both money and time.**

Plus, you get to start enjoying your dream outdoor living space much sooner!

**TO LEARN MORE,
VISIT BELGARD.COM/BPP**

BENEFITS OF BELGARD FINANCING INCLUDE:

- No payments or interest on approved credit
- Quick, easy and safe toll-free loan-by-phone application process
- No paperwork
- A credit decision in about 10 minutes
- No application fees, no closing costs and no prepayment penalties

VISUALIZE YOUR PROJECT

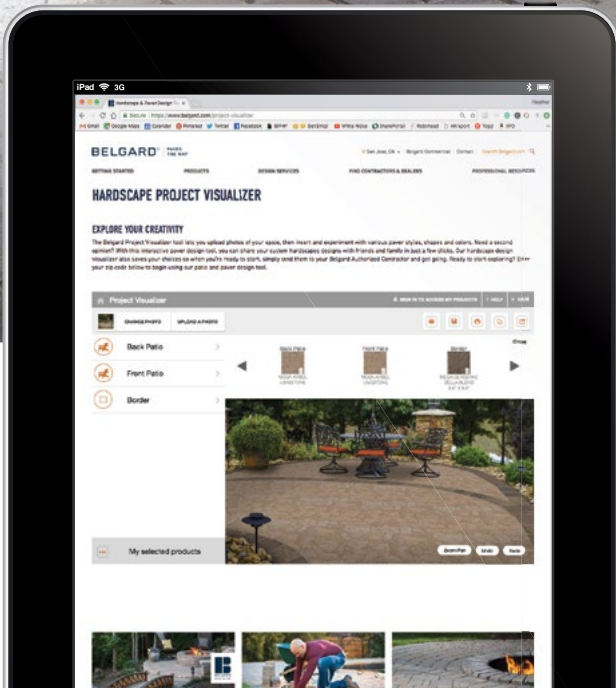
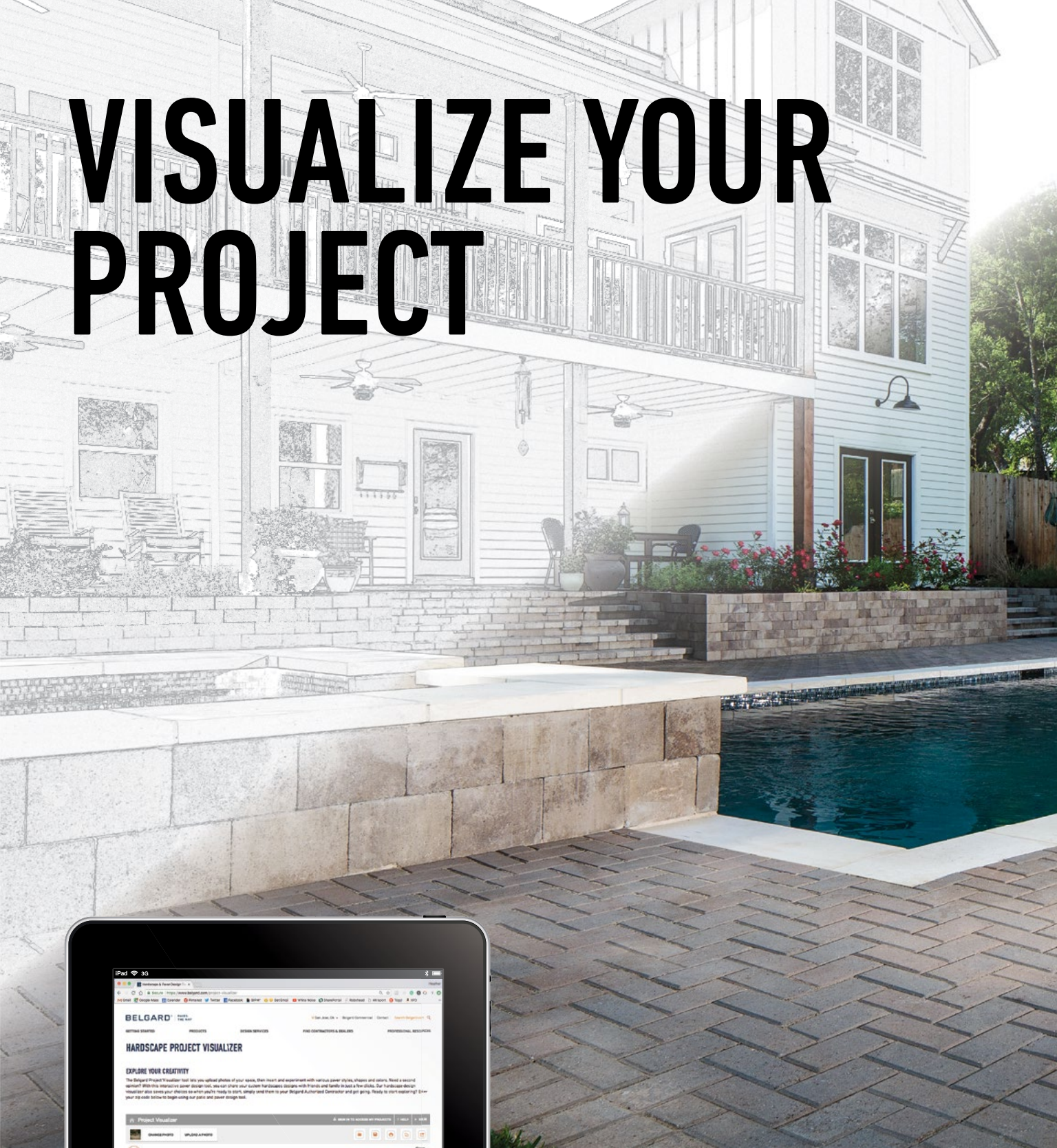

Belgard's online Project Visualizer allows you to be your own hardscape designer. Choose from our image library or upload your own photo to experiment with paver styles and colors and explore an infinite number of design possibilities.

**READY TO "VISUALIZE" YOUR BACKYARD MAKEOVER?
VISIT [BELGARD.COM/SEEIT](https://www.belgard.com/seeit)**

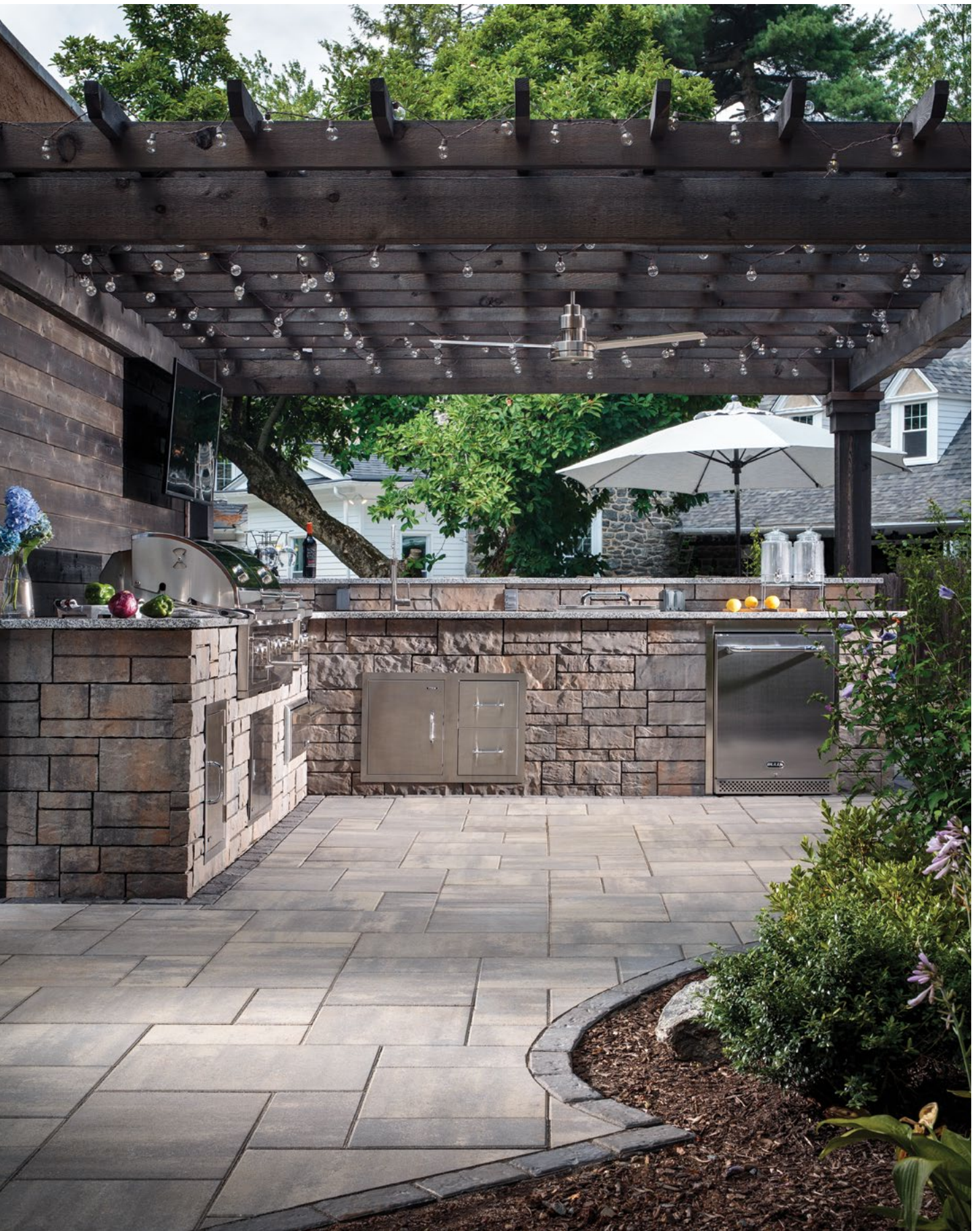

PEACE OF MIND, GUARANTEED

LIFETIME TRANSFERABLE LIMITED WARRANTY

Oldcastle® APG, Inc. ("Belgard") is proud to inform you that all of our interlocking concrete paver and retaining walls ("Products") meet and/or exceed the requirements of ASTM C-936 and ASTM C-1372. Belgard® guarantees its Products against these standards for the lifetime of the Product defined by ICPI. This guarantee does not apply to splitting, chipping or other breakage that could be caused by impact, abrasion or overloading. This warranty is transferable. The original proof of purchase is required.

This warranty is only valid if the material is installed under the guidelines of the ICPI (www.ICPI.org), The NCMA (www.ncma.org) or the Belgard Installation Guideline Manual. Improper installation voids this warranty. This warranty is for residential applications only and does not apply to commercial applications. It is recommended that the job be installed by a Belgard Contractor who provides a guaranty of their workmanship for a minimum of 3 years from the date of install. For warranty service, contact Belgard at 1-800-BELGARD. A service representative will investigate your claim within 10 business days. If the Belgard product fails to meet the specifications, Belgard will replace the defective product at no charge. Color matching cannot be guaranteed. Belgard will not be responsible for any replacement labor, consequential damages or incidental damages. This warranty gives you specific legal rights, and you may also have other rights which vary from state to state. Some states do not allow for the exclusion or limitation of incidental or consequential damages, so the above limitation or exclusion may not apply to you. All other warranties, express or implied are waived.

For specific information regarding warranty coverage and exclusions in regards to the Elements and Porcelain Paver products, please visit: Belgard.com/Warranty

STAY CONNECTED



OutdoorLivingbyBelgard



Belgard



BelgardHardscapes



Belgard



BelgardOutdoorLiving



Belgard.com/Blog



KELLER
2725 Prestige Rd.
Keller, TX 76244
817-337-4408

BRITTMORE
4523 Brittmore Lane
Houston, TX 77041
713-937-3966

AUSTIN
3733 Bluestein Drive
Austin, TX 78721
512-462-3363

DALLAS
2627 Joe Field Rd.
Dallas, TX 75229
972-243-1144

HOUSTON
16745 W. Hardy Rd.
Houston, TX 77060
281-209-0683

ROSENBERG
1607 Spur 529
Rosenburg, TX 77471
281-342-8114

FRISCO
9850 John W. Elliot Dr.
Frisco, TX 75034
972-335-4122

N. GARDEN STREET
11931 N Garden St.
Houston, TX 77071
713-974-1911

WACO
400 Jewell Drive
Waco, TX 76712
254-772-3440

Please visit Belgard.com/find-contractor to locate a Belgard retail dealer or contractor near you.

