



THE BUILDING BLOCKS FOR LUXURY OUTDOOR SPACES™



ELDORADO  OUTDOOR™



THE BUILDING
BLOCKS FOR LUXURY
OUTDOOR SPACES



There's nothing quite like the pleasure of gathering friends and family in your own luxurious outdoor living space. With Eldorado Outdoor, there are a number of ways to create your very own personal retreat ranging from elegant fire bowls to inviting seating walls to beautiful outdoor kitchens. Eldorado Outdoor seamlessly marries design with functionality making it easier than ever to create your memorable space.



The Wilmington Fireplace with Extensions (pg. 30) and Cabinets (pg. 24) finished with Eldorado Stone Padova Fieldledge and Cassis Modena Brick.





Eldorado Outdoor Cabinets (pg. 24) finished with Eldorado Stone Autumn Leaf RoughCut



Eldorado Outdoor Cabinets (pg. 24) finished with Eldorado Stone Birch LedgeCut33

ARTISAN FIRE BOWLS



Warmth, Style & Ambiance. Eldorado Fire Bowls bring a heightened level of design and elegance to any outdoor space. Made from strong, glass-fiber reinforced concrete and hand-sanded through a four-step finishing process. Each Artisan Fire Bowl renders a true one-of-a-kind creation with subtle variations in color and texture similar to natural limestone. Fire Bowls ship complete with lava rock and match-lit components complying with CSA standards for natural gas or liquid propane. Choose from four colors in either Honed or Travertine finishes.



The Infinite in Aged Teak with a Honed Finish.

INFINITE™

The Infinite is limitless in its design applications. The simple, yet elegant shape will naturally draw attention for its style and inviting warmth. Perfect for both residential and commercial applications, the Infinite can change appearance from modern to traditional by selecting the textured Travertine finish.

36.25" DIAMETER x 18.5" H

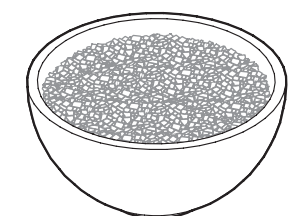



The Mezzaluna in Oyster Shell with a Honed Finish.

MEZZALUNA™

Mezzaluna, which translates to half-moon in Italian, exhibits a low profile at only 15" high with a generous 48" circumference. Its perfect symmetry delivers an elegant simplicity to complement any aesthetic taste.

48" DIAMETER x 15" H

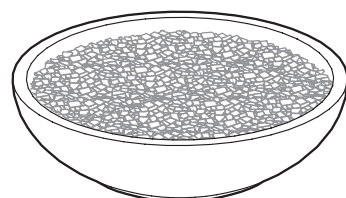

The Marbella in Oak Barrel with a Travertine Finish.

MARBELLA™

The Marbella fire bowl captures the essence of the Romanesque period. Its gently rounded bull nose and elegant foundation are hand-sanded, creating the natural feel and texture of limestone. The Marbella is perfect for a variety of traditional landscape settings.

38.25" DIAMETER x 20.375" H

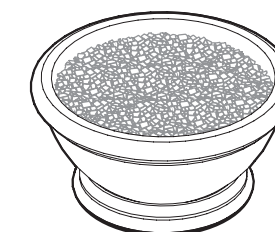



KULM™

Experience the balance and symmetry of the elliptical Kulm fire bowl. Elegant and engaging, the sweeping lines soften the design while commanding attention in any environment.

60" L × 28.75" W × 15" H
 40" L × 20.25" W × 15" H

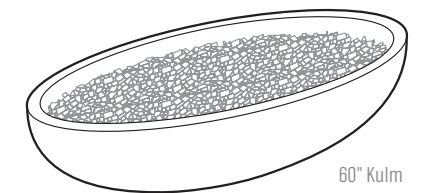

60" Kulm

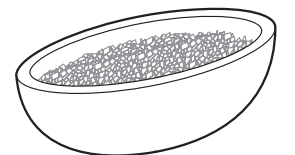

40" Kulm



The Tuya in Black Sand with a Honed Finish.

TUYA™

Create a memorable outdoor area with high design and functionality. The versatile Tuya delivers the best of both worlds incorporating ample table space for entertaining along an artful circular fire feature.

60" L x 36" W x 15" H

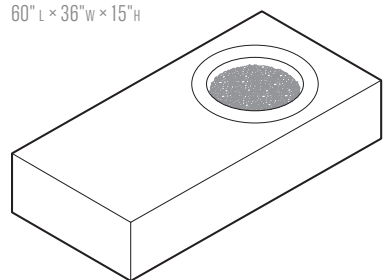

The Talus in Black Sand with a Honed Finish.

TALUS™

The monolithic square design of Talus creates an impressive contemporary centerpiece. Equally pleasing from all angles, this gently sloped circular fire feature will draw friends and family together.

40" SQUARE x 15" H

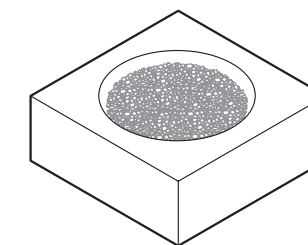



LYRA™

Lyra exudes a modern linear design with a gently sloped fire feature. Sharp 90 degree inset walls add to this unique monolithic concrete design. The ideal application for any residential or commercial outdoor living space.

60" L x 24" W x 15" H
42" L x 24" W x 15" H

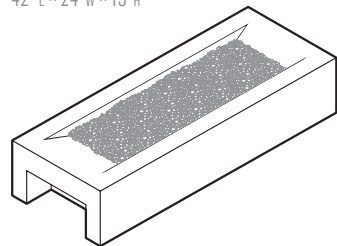

60" Lyra

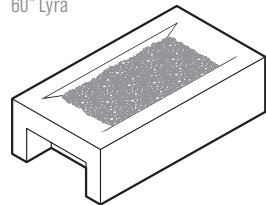

42" Lyra



The Equa in Oyster Shell with a Honed Finish.

EQUA™

The subtle curves of the Equa fire bowl form a pleasing shape ideal for intimate conversation spaces or a personal retreat. Begin or end your day with a cup of relaxation, a favorite book and ample warmth.

20" DIAMETER × 15" H

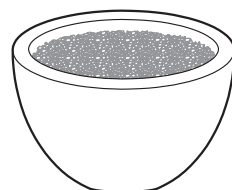

BLOC™

Bloc delivers the perfect balance of simplicity and scale. At only 20" square, Bloc provides a surprising amount of warmth. Anchor small seating areas or highlight outdoor elements with this handsome fire feature.

20" SQUARE × 15" H

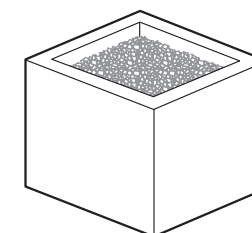

The Bloc in Aged Teak with a Honed Finish.



The Propane Tank Enclosure in Aged Teak with a Honed Finish.

PROPANE TANK ENCLOSURE

When using liquid propane, select a matching Propane Tank Enclosure to discreetly house the tank and create an elegant end table. Available in all the Eldorado Fire Bowl colors and finishes.

19" D × 19" W × 22.375" H



The Artisan Fire Bowl Wood Table Top shown on the Infinite (pg 9).

WOOD TABLE TOPS

Extend the use of your artisan fire bowl with our customized high quality Iroko wood table tops. Available for all fire bowl designs.

OUTDOOR LUXURY MADE SIMPLE, IN JUST 5 STEPS!

Eldorado Outdoor has redefined how to build outdoor living spaces with a collection of strong, yet lightweight building blocks. The blocks quickly assemble into custom barbecue islands, fireplaces, fire pits and more—ready to be dressed with Eldorado Stone and Brick within hours.



The Metropolitan Signature Kitchen (pg. 27) installed with Eldorado Stone Black River Stacked Stone.

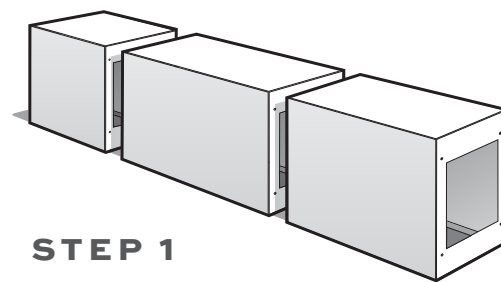

STEP 1
Pre-Planning & Design

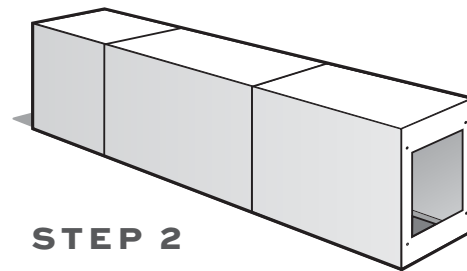

STEP 2
Install Eldorado
Outdoor Cabinets

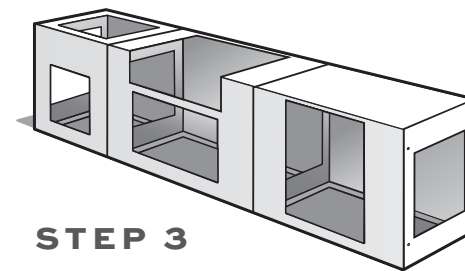

STEP 3
Cut Appliance Openings

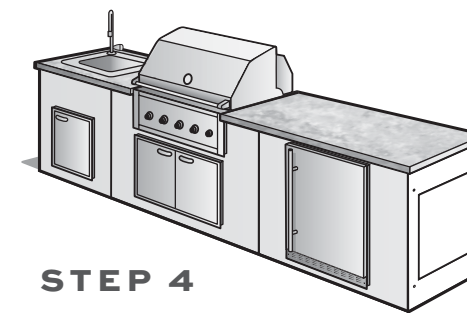

STEP 4
Install Appliances
& Countertop

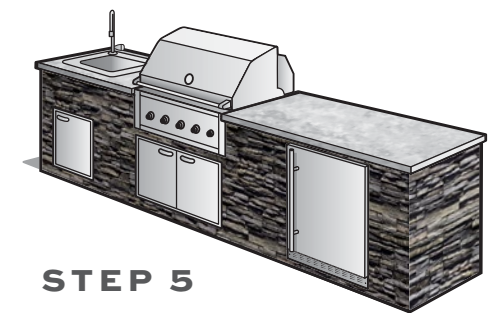

STEP 5
Install Eldorado Stone
or Eldorado Brick

ELDERADO OUTDOOR Vs. CONCRETE BLOCK

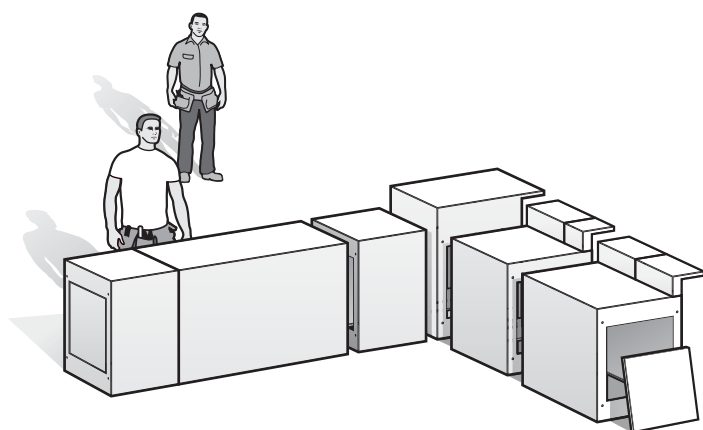

ELDERADO OUTDOOR:

- 6 Outdoor Cabinets
- 4 Raised Backsplashes
- 2 End Caps
- Hand Tools
- 2 People
- 1 Day



CMU CONCRETE BLOCK:

- 160 Qty. Concrete Blocks
- 200 Ft. Rebar
- 45 Qty. Bags of Cement
- Heavy Equipment
- 4 People
- 7 Days



The sheer magnitude of materials, time and manpower required to build a CMU Concrete Block kitchen compared to Eldorado Outdoor is well illustrated in this “example.” Eldorado Outdoor allows you to create beautiful and authentic masonry outdoor spaces in less than half the time compared to traditional building techniques. The strong, yet lightweight material doesn’t require additional concrete footings, bending rebar, or any of the mess, waste and time associated with CMU installations.



Eldorado Outdoor Cabinets (pg. 24) finished with Eldorado Stone Padova Fieldledge.

CABINETS & ACCESSORIES



The Building Blocks. Eldorado Outdoor products quickly assemble into a virtually limitless combination of configurations. Each piece is made of glass-fiber reinforced concrete (GFRC) which can be installed on any solid flooring surface without concrete footings or rebar. Eliminated is the construction waste and additional time associated with traditional masonry block installations.

Eldorado Outdoor products can be assembled in just hours; even cut-outs for custom features such as barbecues, sinks, drawers and burners can be done on-site.

STRAIGHT (LINEAR) CABINETS

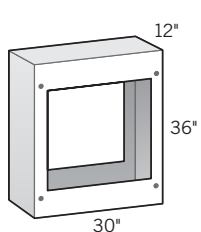

12" Cabinet
30" d × 36" h • OLPLS0012

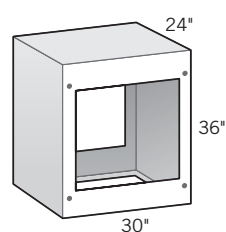

24" Cabinet
30" d × 36" h • OLPLS0024

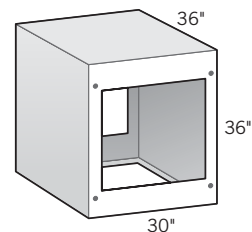

36" Cabinet
30" d × 36" h • OLPLS0036

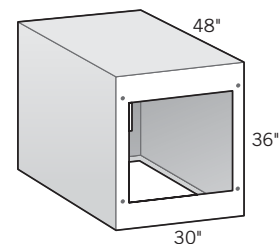

48" Cabinet
30" d × 36" h • OLPLS0048

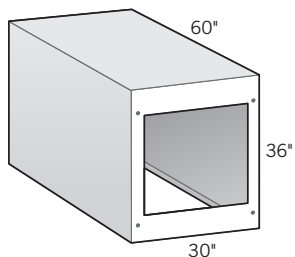

60" Cabinet
30" d × 36" h • OLPLS0060

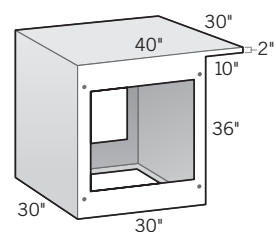

Cabinet with 10" Cantilever Backside
30" d × 30" L × 36" h • OLPLSCHBS

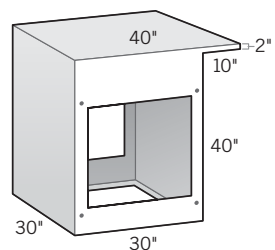

BAR-HEIGHT Cabinet with 10" Cantilever Backside
30" d × 30" L × 40" h • OLPLSBHBS

Eliminated is the construction waste and additional time associated with traditional masonry block installations. Eldorado Outdoor products can be assembled in just hours; even cut-outs for custom features such as barbecues, sinks, drawers and burners can be done on-site.

90° CORNER CABINETS

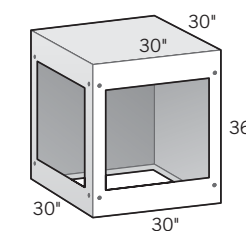

90° Corner Cabinet
30" d × 30" L × 36" h • OLPLS00CN

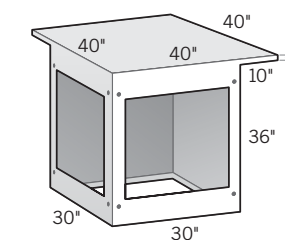

90° Corner Cabinet with 10" Cantilever on Two Sides
30" d × 30" L × 36" h • OLPLSCHBC

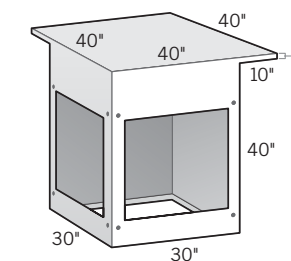

BAR-HEIGHT 90° Corner Cabinet with 10" Cantilever on Two Sides
30" d × 30" L × 40" h • OLPLSBHBC

WALLS, COLUMNS & ACCESSORIES

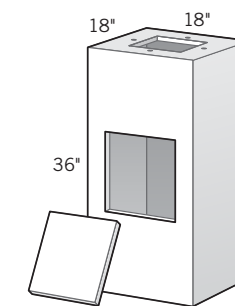

Column with End Cap
18" d × 18" L × 36" h • OLPLS1836
Instantly build perfect stone or brick columns. Column ships with access panel. Designed with top and bottom flange for attaching masonry anchor or bolting.

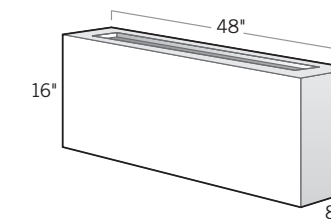

Straight Seating Wall
8" d × 48" L × 16" h • OLPW81648
Create seating walls in hours vs. days. Finish with Eldorado Stone & Wall Caps for an authentic masonry appearance.

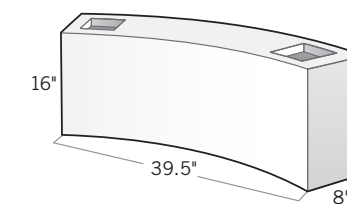

Curved Seating Wall (1/8 Circle)
8" d × 39.5" L × 16" h • OLPW81640
Curved seating wall is designed with a 51" radius from the center point to the inside edge, perfect for pairing with our round fire pit.

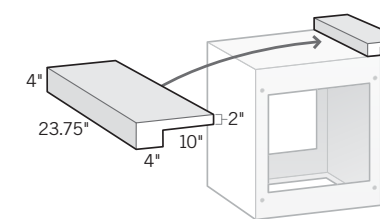

Straight Raised Backsplash
OLPLSBSTR
Creates 4" high raised backsplash (23.75" long) with 10" cantilever and 14" counter surface. Requires 3 bolts for mounting (not included).

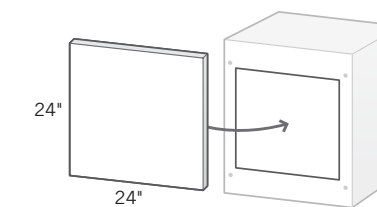

Cabinet End Cap
24" × 24" sq • OLPLSECAP
End Caps complete the installation by closing off openings on either end of assembled island.

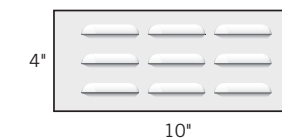

Vent
01000VENT
Vents are recommended by many barbecue appliance manufacturers when installing gas appliances into a closed cabinet.

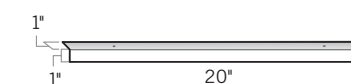

Appliance Bracket Set
OLPLSAB02
Includes 2 brackets & screws for use with drawers, doors, etc. Works with flanges to secure items in cabinet cut-outs.

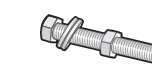

Fastener Set
OLPLSF004
Includes 4 nuts, 4 bolts & 8 washers. One fastener set is required to secure two cabinets.

SIGNATURE KITCHENS™

Pre-Designed, Ready to Install. Signature Kitchens allow you to construct the perfect outdoor kitchen in days vs. weeks. Each kitchen has been pre-designed to fit a variety of size and style configurations and ship complete with all necessary cabinets, bolts and end-caps. Finalize your outdoor design by selecting the Eldorado Stone, appliances and countertop material of your choice.



The ParkView Signature Kitchen installed with Eldorado Stone Autumn Leaf RoughCut.

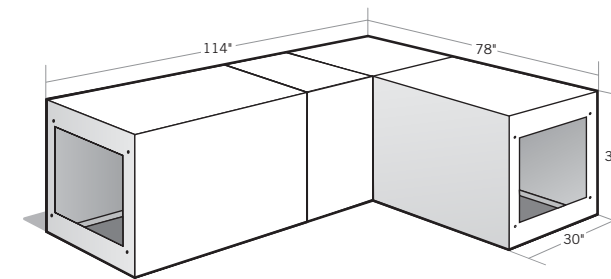

PARKVIEW™

- Includes:**
- 1 Qty. 24" Straight Cabinet
 - 1 Qty. 48" Straight Cabinet
 - 1 Qty. 60" Straight Cabinet
 - 1 Qty. 90" Corner Cabinet
 - 2 Qty. Cabinet End Caps
 - 3 Qty. Fastener Sets
 - 2 Qty. Vents



The CoastalRanch Signature Kitchen installed with Eldorado Stone Veneto Fieldedge.

COASTALRANCH™

- Includes:**
- 2 Qty. 24" Straight Cabinets
 - 1 Qty. 48" Straight Cabinet
 - 1 Qty. Bar-Height 90" Corner Cabinet with 10" Cantilever
 - 2 Qty. Bar-Height Cabinet with 10" Cantilevers
 - 2 Qty. Cabinet End Caps
 - 5 Qty. Fastener Sets
 - 2 Qty. Vents

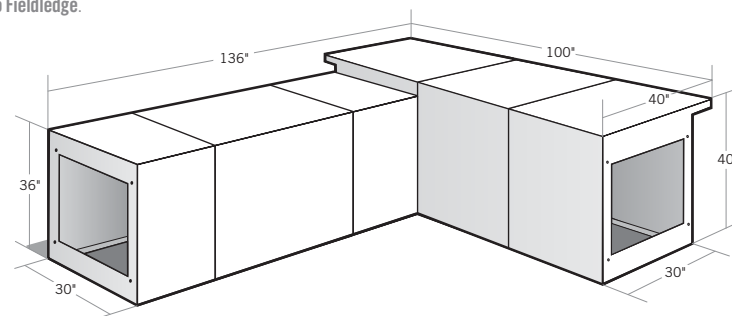

The Metropolitan Signature Kitchen installed with Eldorado Stone Black River Stacked Stone.

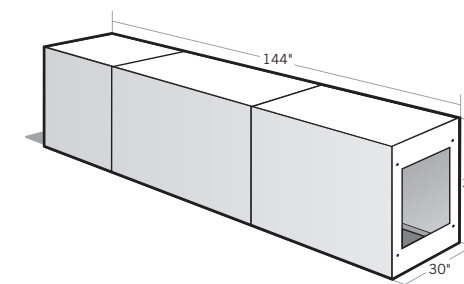

METROPOLITAN™

- Includes:**
- 1 Qty. 36" Straight Cabinet
 - 1 Qty. 48" Straight Cabinet
 - 1 Qty. 60" Straight Cabinet
 - 2 Qty. Cabinet End Caps
 - 2 Qty. Fastener Sets
 - 2 Qty. Vents

FIREPLACES & FIRE PITS

Inviting Fireside Chats. Sitting fireside in your backyard has never been easier. Choose from our unique design options and fuel types for Fireplaces and Fire Pits. Each Fireplace and Fire Pit are ready to be dressed with Eldorado Stone or Brick for the ultimate masonry appearance.

KITTREDGE™ GAS-BURNING FIRE PIT

The Kittredge Fire Pit is the perfect centerpiece to your outdoor room. Combine it with our curved seating walls which match the radius perfectly and you're bound to start some great fireside conversations.

46" DIAMETER × 11.75" H • OLPLSFP48

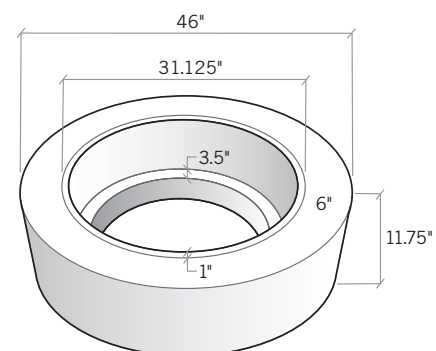



WILMINGTON™ GAS-BURNING FIREPLACE

The Wilmington Fireplace features architectural touches such as an arched opening and cantilevered mantel for an elegant design. Delivered complete with a scratch-coat surface, the Wilmington can be finished for an impressive custom masonry appearance.

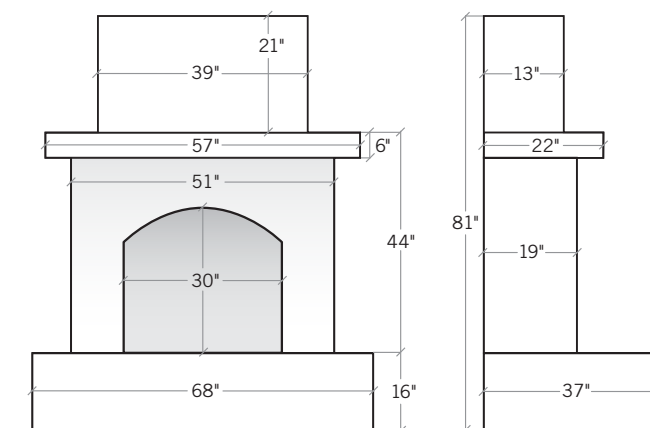

Wilmington Gas-Burning Fireplace
37" D × 68" L × 81" H • OLPLSF01

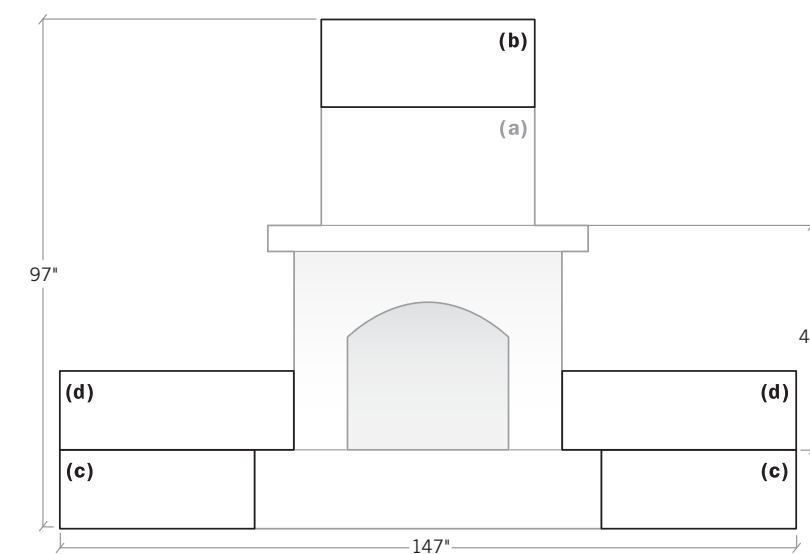

Gas-Burning Fireplace Extensions

(a) Gas-Burning Fireplace OLPLSF01 • (b) Chimney Extension OLPLSF02
(c) Hearth Extension OLPLSF03 • (d) Hearth Extension Backrest OLPW81648

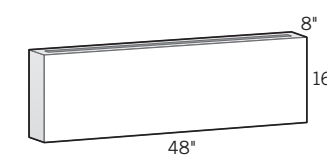

**Wilmington Gas-Burning Fireplace
Hearth Extension Backrest**
8" D × 48" L × 16" H • OLPW81648

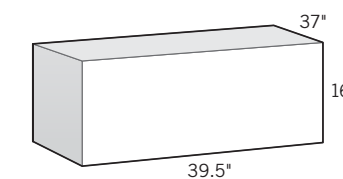

**Wilmington Gas-Burning Fireplace
Hearth Extension**
37" D × 39.5" L × 16" H • OLPLSF03

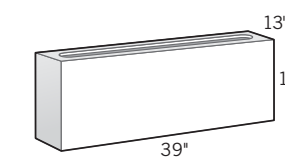

**Wilmington Gas-Burning Fireplace
Chimney Extension**
13" D × 39" L × 16" H • OLPLSF02

SHERWOOD™ WOOD-BURNING FIREPLACE

The Sherwood Fireplace creates a focal point in your open air conversation setting while providing the warmth and pleasant crackle of burning wood. A design statement, the Sherwood can be dressed with any stone and accessories to complement and enhance your outdoor living space.

47" D × 96" L × 93" H • OLPWBFP20

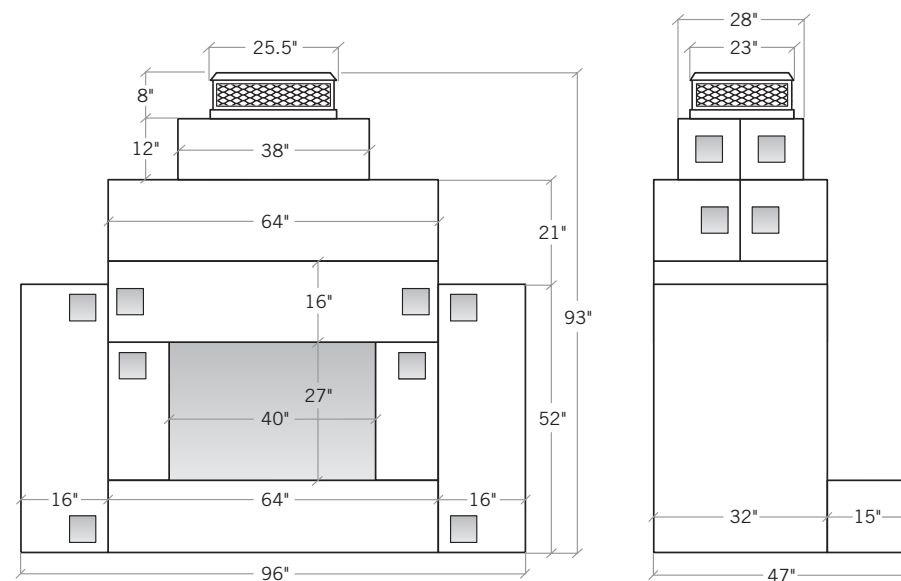

Because Eldorado Outdoor finishes replicate natural stone, variations should, and can be expected. Even though colors in this brochure are as close to the actual product as possible, photographic and printing techniques — and actual viewing conditions — can alter perception of color. It is recommended to obtain a sample of an Eldorado Outdoor finish before ordering.

If you would like more information on prices, availability of products, the name of your local distributor, or answers to any questions not covered in this brochure, please contact us. We would be happy to assist you with your outdoor and stone building plans. Detailed installation instructions, specifications, technical information and test data is available upon request.

800.925.1491 eldoradostone.com/outdoor

Please join us on:

