



CRAFTED WITH PRIDE  IN THE USA



BUILT WITH PASSION. OWNED WITH PRIDE.

Premium Outdoor Grills

# FIREMAGIC®

BUILT WITH PASSION. OWNED WITH PRIDE.

## FIRE MAGIC® BRINGS OUT THE BEST IN YOUR GRILLING

Family owned and crafted in America, Fire Magic® is the name trusted by true grilling enthusiasts for 80 years. With its diverse product line, versatile cooking options, durability and superior design innovations, Fire Magic® is the finest performing grill on the market and it's a shining centerpiece of a lifetime of special moments shared with family and friends.





## **BEAUTIFULLY DESIGNED. BULLET PROOF TOUGH.**

Constructed entirely of the finest quality, heavy-gauge 304 stainless steel with unsurpassed attention to the most precise detail in design and construction. Fire Magic® grills are the most elegant and durable barbecue grills available. They are engineered to perform at the highest temperature for the longest time of any outdoor barbecue grill. Our exclusive advanced heat distribution system, searing options, smoking capability, rotisserie and charcoal grilling features will keep you grilling and the neighbors talking for years to come.

## **BUILT WITH PASSION. OWNED WITH PRIDE.**

Fire Magic® grills are made by people who demand the best, for people who demand the best. Every Fire Magic® grill is manufactured in our U.S. production facility and held to the strictest quality standards and the highest performance metrics. Using state-of-the-art technology guided by the watchful eye and careful hand of master craftsmen, our grills are an investment that pay dividends for years. All backed by the industry's best warranty.





BUILT WITH PASSION. OWNED WITH PRIDE.

# ROOM FOR EVERYTHING BUT IMPROVEMENT



## BETTER

EXCLUSIVE "5 WAYS TO COOK" SYSTEM THAT ALLOWS YOU TO GRILL, SEAR, SMOKE, ROTISSERIE COOK AND CHARCOAL GRILL.

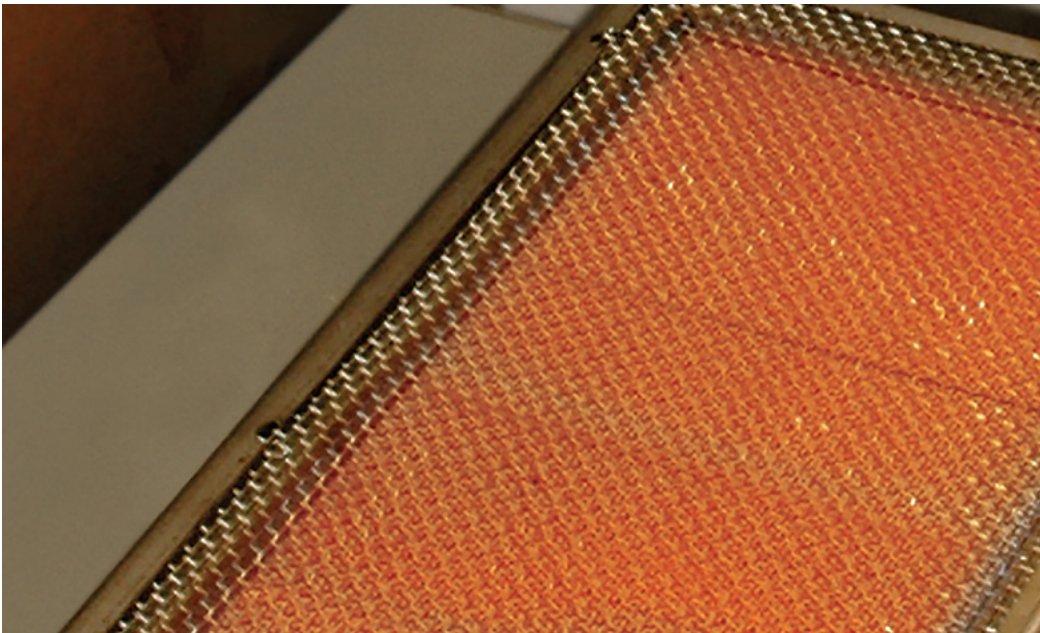

## HOTTER

MOST BTU'S PER SQUARE INCH FIRES UP THE HEAT FASTER AND STAYS HOT.



## ROOMIER

MORE COOKING SURFACE THAN ANY OTHER GRILL.



## TASTIER

STAINLESS STEEL FLAVOR GRIDS MINIMIZE FLARE UPS AND FLAVOR FOOD BY VAPORIZING JUICES.

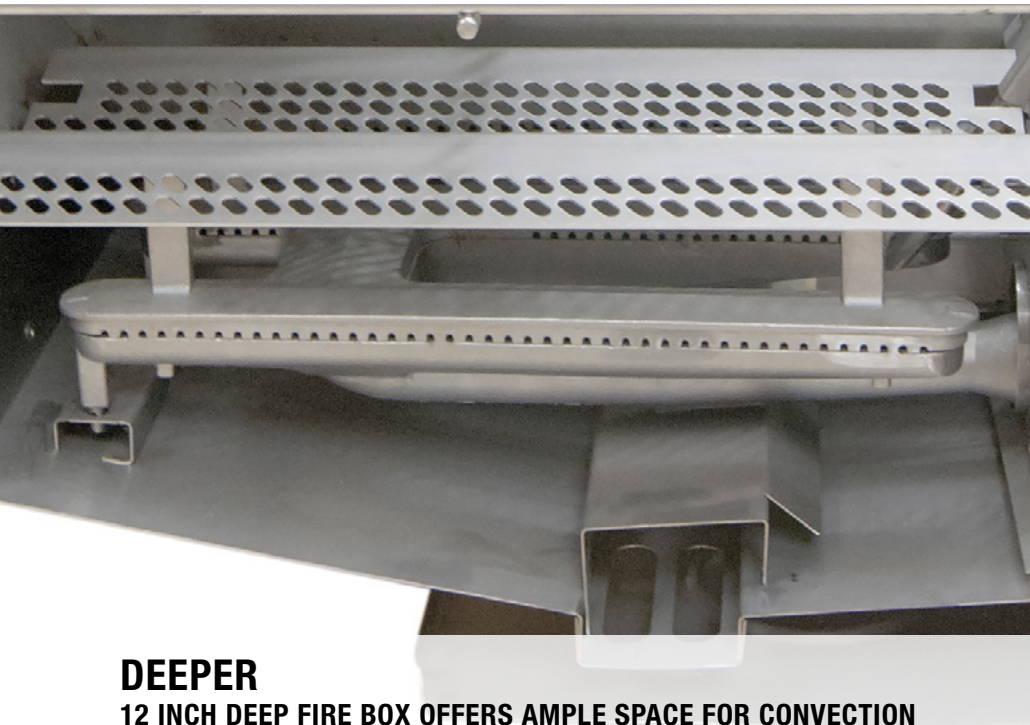

## DEEPER

12 INCH DEEP FIRE BOX OFFERS AMPLE SPACE FOR CONVECTION AND INDIRECT COOKING.

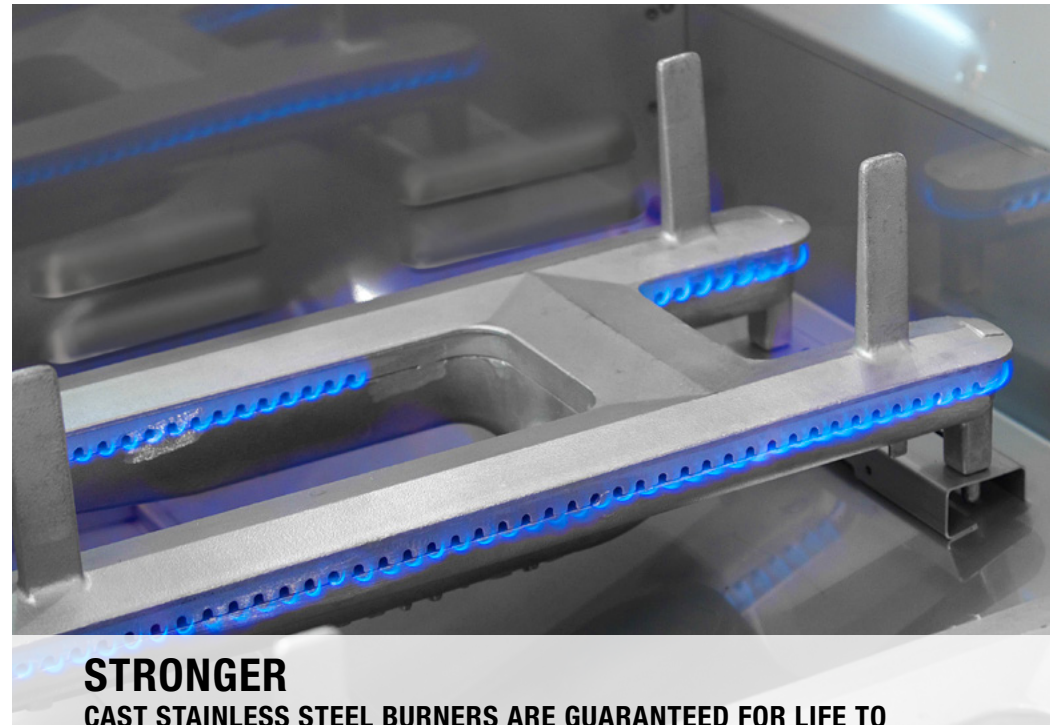

## STRONGER

CAST STAINLESS STEEL BURNERS ARE GUARANTEED FOR LIFE TO DISTRIBUTE HEAT EVENLY.

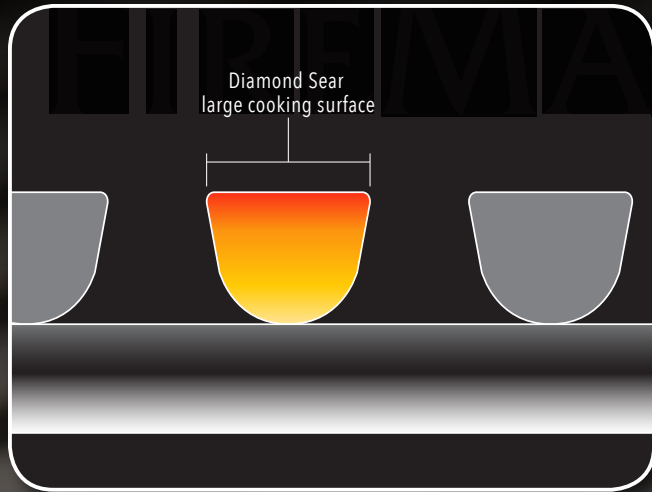

## Diamond Sear Cooking Grids

- Diamond Sear cooking grids promote more optimal heat transfer to food. With more surface area, similar to a griddle, their shape with angled sides improves the flow of heat to the cooking surface.
- Diamond Sear cooking grids are easier to cook on as foods release from the surface more easily with less sticking.
- Diamond Sear cooking grids have more contact surface than round grids. This provides more points of contact that help to sear your meat better and faster.
- More efficient heat transfer and quicker cooking result in less use of gas.

# Advanced Heat Distribution System

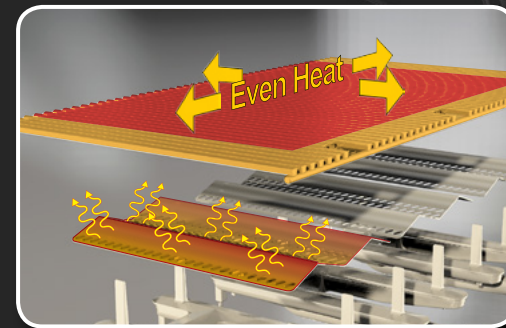
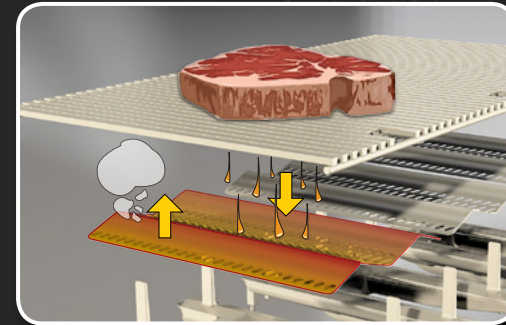

## Flavor Grids

- Heavy gauge stainless steel flavor grids minimize flare ups, provide quick and even heat distribution and flavor food by vaporizing juices.
- Designed to provide distributed heat to the cooking grids; they don't retain or block heat from rising.
- Easy to clean and maintain.
- Simple to remove when rotisserie cooking (for largest rotisserie area).

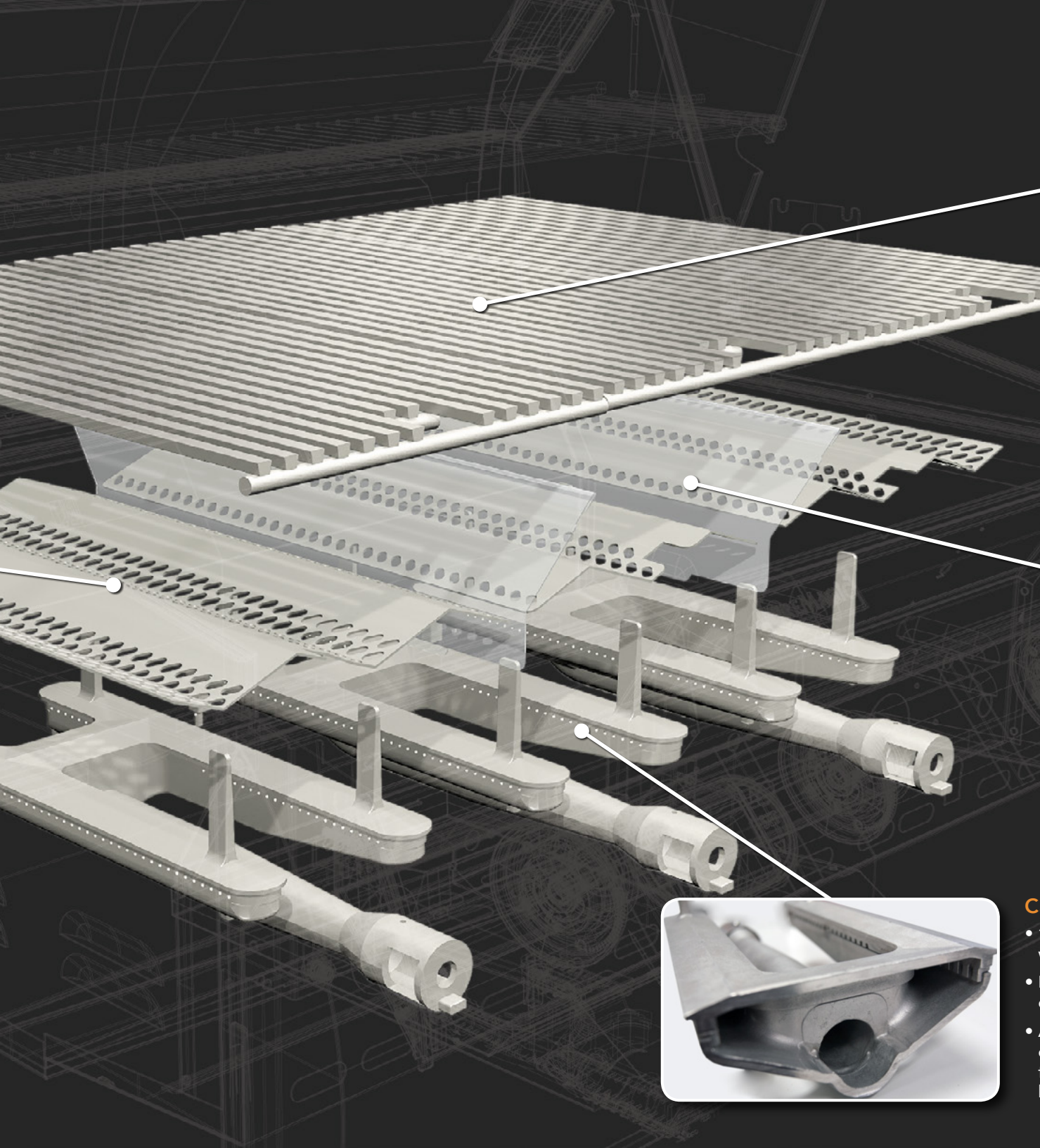

### Largest Cooking Area

Fire Magic® grills provide more cooking area than other grills and more BTU's per square inch of cooking surface.

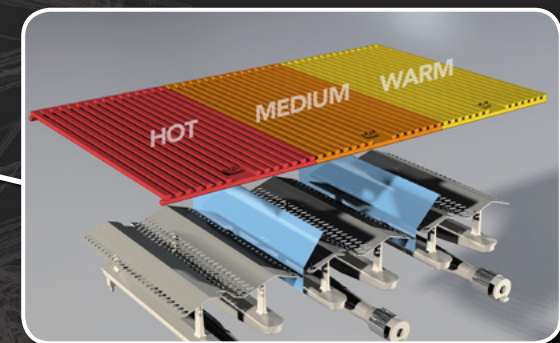

### Echelon Heat Zone Separators

Echelon grills feature heat zone separators between each burner, flavor grid and cooking grid to allow cooking an assortment of foods at different temperatures simultaneously, and also provide better indirect cooking.



### Cast Stainless Steel "E" Burners

- 1/4" thick cast stainless steel burners weighing up to 12 lbs. each.
- Precision porting – cast to be evenly spaced on each burner.
- An internal baffling system, and carry over slots designed for ease of lighting, and balancing flame and heat; to provide well distributed heat, on high or low in each burner.







# ECHELON



## DIAMOND SERIES

When only the best will do, our top of the line Fire Magic® Echelon Diamond combines the ultimate in performance, beauty and innovation. With sleek lines, a unique contoured face and state-of-the-art features such as hot surface ignition, blue back-lit knobs, and an optional Magic View Window, Echelon Diamond defines luxury in grilling.

# ECHELON

DIAMOND SERIES



## Diamond Sear Cooking Grids

All 304 stainless steel cooking grids provide more optimal cooking surface for even heat and great searing.



## Charcoal/Smoker Basket

Included with all Echelon Diamond grills at no additional charge. Great tool for charcoal grilling and smoking.

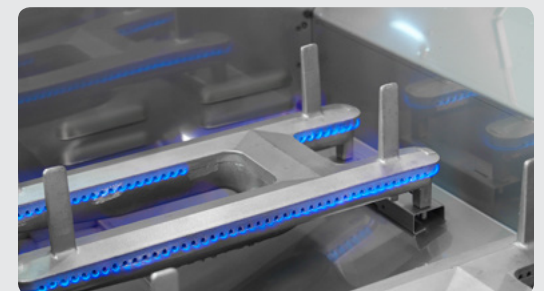

## Cast Stainless Steel Burners

1/4" thick cast stainless steel "E" burners for consistent, even heat and a lifetime of durability.

# Echelon Feature Highlights



## Flavor Grids

16-gauge stainless steel, flavor grids are engineered for durability, even heat distribution and reduced flare-ups.

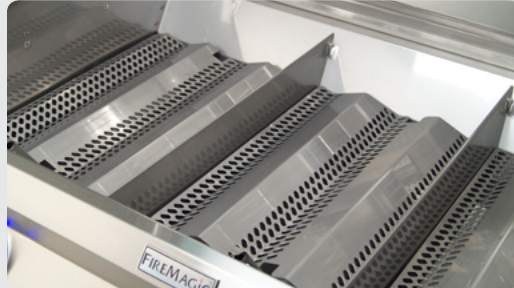

## Heat Zone Separators

Heat zone separators between each burner, flavor grid and cooking grid allow cooking an assortment of foods at different temperatures simultaneously, and provide better indirect cooking.



## Hot Surface Ignition

Hot surface electronic ignition provides reliable lighting for every meal. Requires 120 Volt AC power supply.



## Rounded Oven Hood

Double wall, seamless oven hood (15" high) with featherlight easy lift, rounded for best convection cooking.



## Contoured Face with Back-lit Knobs

Smooth, seamless lines with polished highlights that feature back-lit knobs (at 41°) with comfort touch grips and flame icons for convenience and safety (flame turns red when on).



## Halogen Interior Lights

12 Volt angled interior halogen lights make evening grilling a breeze.

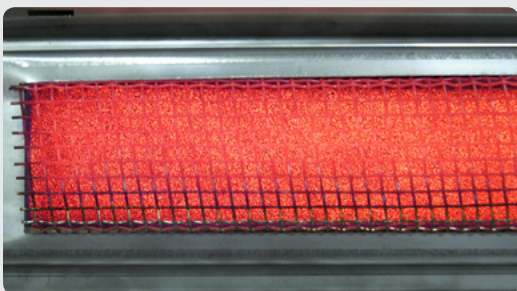

## Quantum Backburner

Recessed Quantum backburner made of stainless steel foam uses less BTU's to generate efficient high heat for rotisserie cooking. Includes complete rotisserie kit with super heavy duty motor, counter-balance, and polished stainless steel cover for protection.



## Digital Thermometer

Illuminated chromed digital thermometer with meat probe, timer and alarm settings for precise grilling.



## Optional Magic View Window

Optional Magic View Window available on all Echelon Diamond Grills. For Echelon "A" Series Grills purchased with a Magic View Window, a Grill Top Thermometer (#3573) is provided at no extra cost.

# ECHELON

DIAMOND SERIES



### Optional Magic View Window

Optional Magic View Window available on **all** Echelon Diamond Grills. For Echelon "A" Series Grills purchased with a Magic View Window, a Grill Top Thermometer (#3573) is provided at no extra cost.



### Charcoal/Smoker Basket

New Charcoal/Smoker Basket included with all Echelon Diamond Grills at no additional charge. Use charcoal or wood chips to add smoke flavor to your food.

## Built-In Grills with Digital Thermometer

### Echelon E1060i, 48" Built-In Grill

**E1060i-4E1N\*-W** (optional Magic View Window shown)

Primary Cooking Surface	48" x 22" (1,056 sq. in.)
Warming Rack Surface	48" x 8" (384 sq. in.)
Main Burners	112,000 BTU's
Backburners	22,000 BTU's (11,000 x 2)
Cut-out Dimensions	50"w x 23½"d x 12"h



### Echelon E790i, 36" Built-In Grill

**E790i-4E1N\***

Primary Cooking Surface	36" x 22" (792 sq. in.)
Warming Rack Surface	36" x 8" (288 sq. in.)
Main Burners	93,000 BTU's
Backburner	13,000 BTU's
Cut-out Dimensions	37"w x 23½"d x 12"h



### Echelon E660i, 30" Built-In Grill

**E660i-4E1N\***

Primary Cooking Surface	30" x 22" (660 sq. in.)
Warming Rack Surface	30" x 8" (240 sq. in.)
Main Burners	75,000 BTU's
Backburner	11,000 BTU's
Cut-out Dimensions	31¼"w x 23½"d x 12"h



\*All models available in natural gas or propane (for propane change N to P in the model number).

## Built-In Grills with Analog Thermometer

### Echelon E1060i "A" Series, 48" Built-In Grill E1060i-4EAN\*

Primary Cooking Surface	48" x 22" (1,056 sq. in.)
Warming Rack Surface	48" x 8" (384 sq. in.)
Main Burners	112,000 BTU's
Backburners	22,000 BTU's (11,000 x 2)
Cut-out Dimensions	50"w x 23½"d x 12"h



### Echelon E790i "A" Series, 36" Built-In Grill E790i-4EAN\*

Primary Cooking Surface	36" x 22" (792 sq. in.)
Warming Rack Surface	36" x 8" (288 sq. in.)
Main Burners	93,000 BTU's
Backburner	13,000 BTU's
Cut-out Dimensions	37"w x 23½"d x 12"h



### Echelon E660i "A" Series, 30" Built-In Grill E660i-4EAN\*

Primary Cooking Surface	30" x 22" (660 sq. in.)
Warming Rack Surface	30" x 8" (240 sq. in.)
Main Burners	75,000 BTU's
Backburner	11,000 BTU's
Cut-out Dimensions	31¼"w x 23½"d x 12"h



## ECHELON DIAMOND SERIES



### Analog Thermometer

Analog Thermometer with polished stainless steel bezel in hood measures up to 1000° F. Largest and most attractive in the industry.

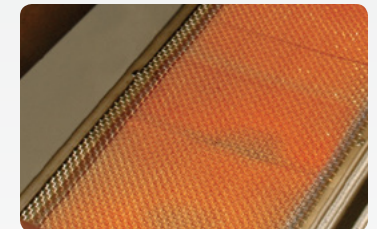

### Optional Infrared Burner

Upgrade to an infrared sear burner in the left hand position at **no charge** on all Echelon Diamond grills.

\*All models available in natural gas or propane (for propane change N to P in the model number).

# ECHELON

DIAMOND SERIES



## Power Burner

The Echelon Power Burner is the largest, most powerful side cooker available and provides the high heat that's perfect for wok cooking or frying a turkey! Offering a range of 3,000 to 60,000 BTU's. Available with porcelain cast iron or stainless steel grids. Removable stainless steel cover included.



## Double Side burner

The Double side burner offers precise flame control on each burner to prepare side dishes and sauces for your meal (Two [2] 15,000 BTU's burners). Includes stainless steel grids as well as removable stainless steel cover.

## Portable Grills with Digital Thermometer

### Echelon E1060s, 48" Portable Grill

**E1060s-4E1N\*-51-W** (Power Burner & optional Window shown)

Primary Cooking Surface	48" x 22" (1,056 sq. in.)
Warming Rack Surface	48" x 8" (384 sq. in.)
Main Burners	112,000 BTU's
Backburners	22,000 BTU's (11,000 x 2)
Power Burner	60,000 BTU's

Also available with a Single Side Burner (-62).



### Echelon E790s, 36" Portable Grill

**E790s-4E1N\*-71** (Double Side Burner shown)

Primary Cooking Surface	36" x 22" (792 sq. in.)
Warming Rack Surface	36" x 8" (288 sq. in.)
Main Burners	93,000 BTU's
Backburner	13,000 BTU's
Double Side Burner	30,000 BTU's (15,000 x 2)

Also available with a Single Side Burner (-62).



### Echelon E660s, 30" Portable Grill

**E660s-4E1N\*-62** (Single Side Burner shown)

Primary Cooking Surface	30" x 22" (660 sq. in.)
Warming Rack Surface	30" x 8" (240 sq. in.)
Main Burners	75,000 BTU's
Backburner	11,000 BTU's
Single Side Burner	15,000 BTU's

Also available with a Double Side Burner (-71).



\*All models available in natural gas or propane (for propane change N to P in the model number).

## Portable Grills with Analog Thermometer

### Echelon E1060s "A" Series, 48" Portable Grill

**E1060s-4EAN\*-62** (Single Side Burner shown)

Primary Cooking Surface	48" x 22" (1,056 sq. in.)
Warming Rack Surface	48" x 8" (384 sq. in.)
Main Burners	112,000 BTU's
Backburners	22,000 BTU's (11,000 x 2)
Single Side Burner	15,000 BTU's

Also available with a Power Burner (-51).



### Echelon E790s "A" Series, 36" Portable Grill

**E790s-4EAN\*-71** (Double Side Burner shown)

Primary Cooking Surface	36" x 22" (792 sq. in.)
Warming Rack Surface	36" x 8" (288 sq. in.)
Main Burners	93,000 BTU's
Backburner	13,000 BTU's
Double Side Burner	30,000 BTU's (15,000 x 2)

Also available with a Single Side Burner (-62).



### Echelon E660s "A" Series, 30" Portable Grill

**E660s-4EAN\*-62** (Single Side Burner shown)

Primary Cooking Surface	30" x 22" (660 sq. in.)
Warming Rack Surface	30" x 8" (240 sq. in.)
Main Burners	75,000 BTU's
Backburner	11,000 BTU's
Single Side Burner	15,000 BTU's

Also available with a Double Side Burner (-71).



## ECHELON DIAMOND SERIES



### Extended Side Shelves

Capped with matching polished handles, new expansive side shelves (20" each) offer the most preparation space of any portable grill. When not in use, they fold down neatly to save space.



### Single Side Burner

Features of this single side burner include a 15,000 BTU's burner, and precise flame control valve. Includes stainless steel grid.

\*All models available in natural gas or propane (for propane change N to P in the model number).



A stainless steel grill with a rotisserie. The rotisserie is currently cooking several large pieces of meat. The grill has a control panel with five knobs and a digital display. The brand name "Fire Magic" is visible on the front panel.

A side burner on the left side of the grill. It has a control knob and is currently heating a pot. The brand name "Fire Magic" is visible on the front panel.

A built-in refrigerator on the right side of the grill. It has a stainless steel frame and a black door. The brand name "Fire Magic" is visible on the top right corner of the door.

Decorative lanterns on the right side of the grill. They are made of metal and have a glass front. One is lit, casting a warm glow.

Plates of food on the right side of the grill. There are several plates, including one with a large piece of meat and another with a salad.

Plants on the left side of the grill. There is a large green plant in a pot and some smaller plants in a planter.







# *Black Diamond*

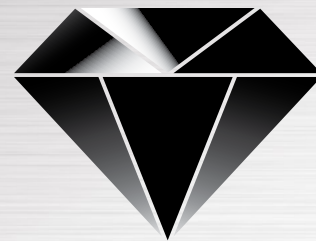

The Black Diamond Edition Grill Series showcases a porcelain coated finish with satin stainless steel accents. Featuring our top of the line Fire Magic® Echelon Diamond, this grill creates a fusion of performance, beauty and innovation. With sleek lines, a unique contoured face and state-of-the-art features such as hot surface ignition, blue back-lit knobs and a Magic View Window, the Echelon Black Diamond Series redefines luxury in grilling.



### Magic View Window

The Black Diamond built-in grill features a Magic View Window as a standard feature.



### Satin Stainless Steel Knobs

Back-lit, satin stainless steel safety control knobs (flame turns red when on blue when off).

## Echelon Black Diamond Edition

### Echelon H790i Black Diamond, 36" Built-In Grill H790i-4E1N\*-W

Primary Cooking Surface	36" x 22" (792 sq. in.)
Warming Rack Surface	36" x 8" (288 sq. in.)
Main Burners	93,000 BTU's
Backburner	13,000 BTU's
Cut-out Dimensions	37" w x 23½" d x 12" h

Model includes Magic View Window as a standard feature.



### Black Diamond Power Burner

19-HB1N\*-0 (with stainless steel grids)

Burner	60,000 BTU's
Cut-out Dimensions	19" w x 18¾" d x 12" h

Power Burner includes black protective lid.

Available with porcelain cast iron or stainless steel grids.



### Black Diamond Double Side Burner

32814H\* (with stainless steel grids)

Burners	30,000 BTU's (15,000 x 2)
Cut-out Dimensions	11½" w x 22¾" d x 12" h

Double Side Burner includes black protective lid.

Available with porcelain cast iron or stainless steel grids.



\*Models available in natural gas or propane.



**Double Access Doors**  
**53938HSC**

Cut-out Dimensions 16" h x 39" w

*Black Diamond Edition reduced height double doors.*



**Single Access Door**  
**53920HSC-L (-R)**

Cut-out Dimensions 21" h x 14½" w

*Black Diamond Edition single access door.*



**Single Door w/Tank Tray & Louvers**  
**53820HSC-TL (-TR)**

Cut-out Dimensions 21" h x 14½" w x 20½" d

*Black Diamond Edition single access door with LP tank tray and louvers.*



**Black Diamond Refrigerator**  
**3598H-DR (-DL)**

Cut-out Dimensions 20" w x 21¼" d x 34⅞" h

*Features Black Diamond Edition accents, 4.0 cubic feet of space, interior light and security lock & key. When used outdoors, it must be installed in an enclosure.*



**Black Diamond Trash Cabinet**  
**53820HTSC**

Cut-out Dimensions 21" h x 14½" w x 19¼" d

*Black Diamond Edition Trash Cabinet includes two 3.25 gallon trash bins (1 black, 1 blue). Also, features Soft-Close mechanism.*



**Black Diamond GFRC Island**  
**DH790-SMR-108BA**

Overall Dimensions 107½" w x 34¾" d x 36" h

*Black Diamond Edition GFRC Island with Smoke Base, Polished Black Lava Top & black trim. Black Diamond grill components sold separately.*

# AURORA

S E R I E S

Superior design and engineering power the Aurora's unparalleled performance. With many of the same features as its sister Echelon Series, the Aurora Series grill delivers cooking versatility, durability and longevity in a beautifully crafted machine.



# Aurora Feature Highlights



## Diamond Sear Cooking Grids

All 304 stainless steel cooking grids provide more cooking surface area for even heat and great searing.



## Analog Thermometer

Analog thermometer with polished stainless steel bezel in hood measures up to 1000° F.



## Hot Surface Ignition

Hot surface electronic ignition provides reliable lighting for every meal. Requires 120 Volt AC power supply.



## Back-Lit Comfort Touch Knobs

Back-lit knobs are at a 41° angle for intuitive operation; they feature comfort-touch grips and flame icons for convenience and safety (flame turns red when on).

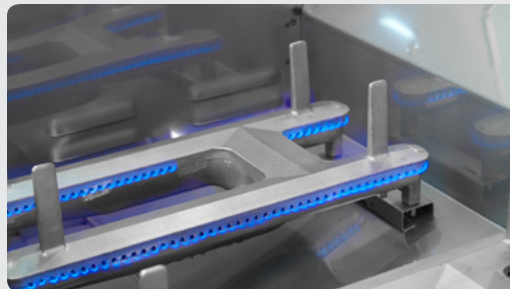

## Cast Stainless Steel Burners

1/4" thick cast stainless steel "E" burners for consistent, even heat and a lifetime of durability.



## Halogen Interior Lights

Interior halogen lights make evening grilling a breeze.



## Gourmet Face

Seamless control panel with satin finish. Optional digital thermometer available as an upgrade.



## Stainless Steel Backburner

Optional stainless steel backburner and a complete rotisserie kit with heavy duty motor, counter-balance, and a polished stainless steel cover for protection.



## Optional Magic View Window

Optional Magic View Window available on Aurora A790 and A660; a Grill Top Thermometer (#3573) is provided at no extra cost.

# AURORA

S E R I E S



### Magic View Window

Optional Magic View Window available on Aurora A790 and A660; a Grill Top Thermometer (#3573) is provided at no extra cost.



### Hot Surface Ignition

All Aurora grills feature push-to-light hot surface electronic ignition system for quick, reliable starts.

## Built-In Grills with Analog Thermometer

### Aurora A790i, 36" Built-In Grill

**A790i-6EAN\*-W** (optional Magic View Window shown)

Primary Cooking Surface	36" x 22" (792 sq. in.)
Warming Rack Surface	36" x 8" (288 sq. in.)
Main Burners	93,000 BTU's
Backburner	20,000 BTU's
Cut-out Dimensions	37¾" w x 23½" d x 12" h

For Aurora Analog grills purchased with the Magic View Window option, a Grill Top Thermometer (Model #3573) is provided at no extra cost.



### Aurora A660i, 30" Built-In Grill

**A660i-6EAN\*** (with Analog Thermometer shown)

Primary Cooking Surface	30" x 22" (660 sq. in.)
Warming Rack Surface	30" x 8" (240 sq. in.)
Main Burners	75,000 BTU's
Backburner	18,000 BTU's
Cut-out Dimensions	32" w x 23½" d x 12" h

A660 model may be upgraded to Magic View Window (-W).



### Aurora A540i, 30" Built-In Grill

**A540i-6EAN\*** (with Analog Thermometer shown)

Primary Cooking Surface	30" x 18" (540 sq. in.)
Warming Rack Surface	30" x 8" (240 sq. in.)
Main Burners	63,000 BTU's
Backburner	18,000 BTU's
Cut-out Dimensions	32" w x 19½" d x 12" h



\* All models available in natural gas or propane (for propane change N to P in the model number).

- All models (except A790) are also available without backburner & rotisserie; change the 6th digit to a "5".

- For Digital Thermometer on Aurora Grills (except A830), factory installed in place of Analog Thermometer, change 8th digit to a "1".

## Built-In Grills with Analog Thermometer

### Aurora A530i, 24" Built-In Grill

**A530i-6EAN\*** (with Analog Thermometer shown)

Primary Cooking Surface	24" x 22" (528 sq. in.)
Warming Rack Surface	24" x 8" (192 sq. in.)
Main Burners	60,000 BTU's
Backburner	13,000 BTU's
Cut-out Dimensions	25½"w x 23½"d x 12"h



### Aurora A430i, 24" Built-In Grill

**A430i-6EAN\*** (with Analog Thermometer shown)

Primary Cooking Surface	24" x 18" (432 sq. in.)
Warming Rack Surface	24" x 8" (192 sq. in.)
Main Burners	50,000 BTU's
Backburner	13,000 BTU's
Cut-out Dimensions	25½"w x 19½"d x 12"h



### Aurora A830i Gas/Charcoal Combo Built-In Grill

**A830i-6EAN\*-CB** (with Analog Thermometer shown)

Primary Cooking Surface	<i>Gas Side</i> 24" x 18" = (828 sq. in.)	<i>Charcoal Side</i> 22" x 18" = (396 sq. in.)
Warming Rack Surface	<i>Gas Side</i> 24" x 8" = (368 sq. in.)	<i>Charcoal Side</i> 22" x 8" = (176 sq. in.)
Main Burners	50,000 BTU's	
Backburner	13,000 BTU's	
Charcoal Igniter	26,000 BTU's	
Cut-out Dimensions	50¼"w x 19½"d x 12"h	

Halogen Lights and Backburner for the A830i model are located on the gas side of the grill only.



# AURORA

S E R I E S



### Optional Digital Thermometer

Upgrade to a Digital Thermometer in control panel with meat probe for an additional charge.  
(Not available on A830 models)

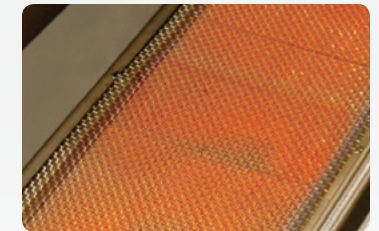

### Optional Infrared Burner

Upgrade to an infrared sear burner in the left hand position for an additional charge.

\* All models available in natural gas or propane (for propane change N to P in the model number).

- All models (except A790) are also available without backburner & rotisserie; change the 6th digit to a "5".

- For Digital Thermometer on Aurora Grills (except A830), factory installed in place of Analog Thermometer, change 8th digit to a "1".

# AURORA

S E R I E S



## Single Side Burner

Aurora Portable Grills (A660s, A540s, & A430s) include a flush mounted side burner on the left side shelf as well as a folding right shelf. They are also available without the side burner, allowing for two folding side shelves.



## Hot Surface Ignition

All Aurora grills feature push-to-light hot surface electric ignition system for quick, reliable starts.



## Optional Digital Thermometer

Upgrade to a Digital Thermometer in control panel with meat probe for an additional charge. (Not available on A830 models)

## Portable Grills with Analog Thermometer

### Aurora A660s, 30" Portable Grill w/Single Side Burner A660s-6EAN\*-62 (with Analog Thermometer shown)

Primary Cooking Surface	30" x 22" (660 sq. in.)
Warming Rack Surface	30" x 8" (240 sq. in.)
Main Burners	75,000 BTU's
Backburner	18,000 BTU's
Single Side Burner	15,000 BTU's

A660 model may be upgraded to Magic View Window (-W).



### Aurora A540s, 30" Portable Grill w/Single Side Burner A540s-6EAN\*-62 (with Analog Thermometer shown)

Primary Cooking Surface	30" x 18" (540 sq. in.)
Warming Rack Surface	30" x 8" (240 sq. in.)
Main Burners	63,000 BTU's
Backburner	18,000 BTU's
Single Side Burner	15,000 BTU's



### Aurora A430s, 24" Portable Grill w/Single Side Burner A430s-6EAN\*-62 (with Analog Thermometer shown)

Primary Cooking Surface	24" x 18" (432 sq. in.)
Warming Rack Surface	24" x 8" (192 sq. in.)
Main Burners	50,000 BTU's
Backburner	13,000 BTU's
Single Side Burner	15,000 BTU's



\* All models available in natural gas or propane (for propane change N to P in the model number).

- All models are also available without backburner & rotisserie; change the 6th digit to a "5".

- For Digital Thermometer on Aurora Grills (except A830), factory installed in place of Analog Thermometer, change 8th digit to a "1".



## Post Mount & Portable Grills with Analog Thermometer

### Aurora A430s, 24" Patio Post Mount Grill

**A430s-6EAN\*-P6** (with Analog Thermometer shown)

Primary Cooking Surface	24" x 18" (432 sq. in.)
Warming Rack Surface	24" x 8" (192 sq. in.)
Main Burners	50,000 BTU's
Backburner	13,000 BTU's

Includes a **one-hour safety timer** that automatically shuts off the gas supply.



### Aurora A430s, 24" In-Ground Post Mount Grill

**A430s-6EAN\*-G6** (with Analog Thermometer shown)

Primary Cooking Surface	24" x 18" (432 sq. in.)
Warming Rack Surface	24" x 8" (192 sq. in.)
Main Burners	50,000 BTU's
Backburner	13,000 BTU's

Includes a **one-hour safety timer** that automatically shuts off the gas supply.



### Aurora A830s Gas/Charcoal Combo Portable Grill

**A830s-6EAN\*-CB** (with Analog Thermometer shown)

Primary Cooking Surface	Gas Side	24" x 18" = (828 sq. in.)
	Charcoal Side	22" x 18" = (396 sq. in.)
Warming Rack Surface	Gas Side	24" x 8" = (368 sq. in.)
	Charcoal Side	22" x 8" = (352 sq. in.)
Main Burners		50,000 BTU's
Backburner		13,000 BTU's
Charcoal Igniter		26,000 BTU's

Halogen Lights and Backburner for the A830i model are located on the gas side of the grill only.



# AURORA

S E R I E S



#### Optional Tank Shield

(Model: 5110-33)

Optional stainless steel LP tank shield

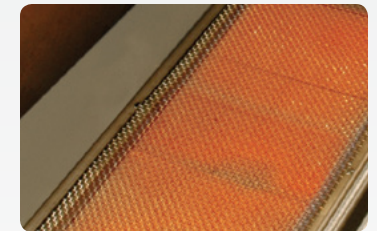

#### Optional Infrared Burner

Upgrade to an infrared sear burner in the left hand position for an additional charge.

\* Models available in natural gas or propane (for propane change N to P in the model number).

- All models are also available without backburner & rotisserie; change the 6th digit to a "5".

- For Digital Thermometer on Aurora Grills (except A830), factory installed in place of Analog Thermometer, change 8th digit to a "1".



# CHOICE

S E R I E S

Our most affordable line, Fire Magic® Choice grills feature superior design and materials housed in an Aurora style grill with a simple satin stainless steel façade.



### U-Shaped S.S. Burners

14-gauge stainless steel burners for durability and even heat.

## Built-In Grills



### Choice C540i, 30" Built-In Grill C540i-1T1N\*

Primary Cooking Surface	30" x 18" (540 sq. in.)
Warming Rack Surface	30" x 8" (240 sq. in.)
Main Burners	57,000 BTU's
Cut-out Dimensions	32"w x 19½"d x 12"h



### Choice C430i, 24" Built-In Grill C430i-1T1N\*

Primary Cooking Surface	24" x 18" (432 sq. in.)
Warming Rack Surface	24" x 8" (192 sq. in.)
Main Burners	46,000 BTU's
Cut-out Dimensions	25½"w x 19½"d x 12"h

\* All models available in natural gas or propane (for propane change N to P in the model number).

Portable & Post Mount Grills

**CHOICE**  
S E R I E S



**Choice C540s, 30" Portable Grill**  
**C540s-1T1N\*-96**

Primary Cooking Surface	30" x 18" (540 sq. in.)
Warming Rack Surface	30" x 8" (240 sq. in.)
Main Burners	57,000 BTU's



**Choice C430s, 24" Portable Grill**  
**C430s-1T1N\*-96**

Primary Cooking Surface	24" x 18" (432 sq. in.)
Warming Rack Surface	24" x 8" (192 sq. in.)
Main Burners	46,000 BTU's



**Rigid Side Shelves**

Solid rigid side shelves provide ample food preparation space.



**Choice C430s, 24" Patio Post Mount Grill**  
**C430s-1T1N\*-P6**

Primary Cooking Surface	24" x 18" (432 sq. in.)
Warming Rack Surface	24" x 8" (192 sq. in.)
Main Burners	46,000 BTU's

Includes a **one-hour** mechanical timer on post.



**Choice C430s, 24" In-Ground Post Mount Grill**  
**C430s-1T1N\*-G6**

Primary Cooking Surface	24" x 18" (432 sq. in.)
Warming Rack Surface	24" x 8" (192 sq. in.)
Main Burners	46,000 BTU's

Includes a **one-hour** mechanical timer on post.



**Optional Tank Shield**  
*(Model: 5110-33)*

Optional stainless steel LP tank shield.

\* All models available in natural gas or propane (for propane change N to P in the model number).



# ELECTRIC

---

## G R I L L S

The Fire Magic® Electric Grill provides quick, clean, and easy grilling. Great for patios with limited space, or where gas fuel is unavailable.

- All 304 stainless steel construction
- Heats up to 800° F (1800 watt grill)
- 252 sq. inches of grilling space
- Stainless steel cooking grids
- 120 Volt. Just plug in and use
- Digital thermometer with thermostatic control and meat probe for precision grilling
- Double walled oven lid
- Easy to clean drip tray
- Substantial (largest, thickest) heating element for faster, hotter cooking
- Removable warming rack
- Optional rotisserie kit upgrade
- Folding side shelves for easy storage

## Electric Grills

### Electric Table Top Grill

#### E250t-1Z1E

Cooking Surface	15½" x 16¼" (252 sq. in.)
Warming Rack Surface	16" x 4" (64 sq. in.)
Power Required	120 Volt



# ELECTRIC GRILLS

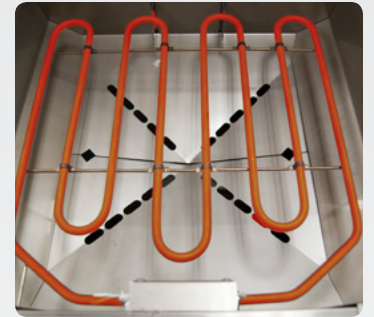

### Electric Heating Element

Larger, thicker heating element for faster and more even heat.

### Electric Patio Post Mount Grill

#### E250s-1Z1E-P6

Cooking Surface	15½" x 16¼" (252 sq. in.)
Warming Rack Surface	16" x 4" (64 sq. in.)
Power Required	120 Volt



### Digital Thermometer

Digital thermometer with meat probe for precision grilling.



# LEGACY

COLLECTION

Uniquely, architecturally designed, this exclusive Drop-In style grill will make your outdoor kitchen look and feel like a unique wonder.

## Regal I Drop-In Grill

### Regal I Drop-In Grill 34-S2S1N\*-A (with Backburner Rotisserie shown)

Primary Cooking Surface	30" x 18" (540 sq. in.)
Warming Rack Surface	30" x 8" (240 sq. in.)
Main Burners	66,000 BTU's
Backburner	22,000 BTU's
Cut-out Dimensions	41½"w x 20½"d x 18"h

Features Diamond Sear cooking grids.

Available without rotisserie backburner (Model # 34-S1S1N-A).



\* All models available in natural gas or propane (for propane change N to P in the model number).

## Deluxe Grills

### Deluxe Gourmet Drop-In Grill 3C-S1S1N\*-A

Primary Cooking Surface	23" x 16" (368 sq. in.)
Warming Rack Surface	23" x 8" (184 sq. in.)
Main Burners	42,000 BTU's
Cut-out Dimensions	29½"w x 16½"d x 14"h



### Deluxe Classic Drop-In Grill 31-S1S1N\*-A

Primary Cooking Surface	23" x 16" (368 sq. in.)
Warming Rack Surface	23" x 8" (184 sq. in.)
Main Burners	42,000 BTU's
Cut-out Dimensions	24¼"w x 19¼"d x 12"h



### Deluxe Built-In Grill 11-S1S1N\*-A

Primary Cooking Surface	23" x 16" (368 sq. in.)
Burners	42,000 BTU's
Cut-out Dimensions	24¾"w x 17¾"d x 12"h



# LEGACY COLLECTION



### Drop-In Grills

The Fire Magic® Legacy Drop-In grills are an exclusively designed, space conscious unit for a unique look. Only Fire Magic® offers the Drop-In grill to enhance your outdoor kitchen.



### Cast Stainless Steel Burners

Cast stainless steel burners offer a classic durability that Fire Magic® is known for.

\* All models available in natural gas or propane (for propane change N to P in the model number).



# CHARCOAL GRILLS

High performance charcoal grills are available in a variety of models including Built-In, Portable, Post Mount and Drop-In. Fire Magic® delivers quality and style to the charcoal grill enthusiast.



## Adjustable Hood Vents

Stainless Steel Charcoal Grills feature a smoker hood with adjustable hood vents to regulate airflow.

## Stainless Steel Charcoal Grills

### 30" Charcoal Built-In Grill (14-SC01C-A shown)

Primary Cooking Surface	30" x 18" (540 sq. in.)
Warming Rack Surface	30" x 12" (360 sq. in.)
Cut-out Dimensions	32¼"w x 19¾"d x 12"h

### 24" Charcoal Built-In Grill (12-SC01C-A)

Primary Cooking Surface	24" x 18" (432 sq. in.)
Warming Rack Surface	24" x 12" (288 sq. in.)
Cut-out Dimensions	26¼"w x 19¾"d x 12"h

### 30" Charcoal Portable Grill (24-SC01C-61 shown)

Primary Cooking Surface	30" x 18" (540 sq. in.)
Warming Rack Surface	30" x 12" (360 sq. in.)

### 24" Charcoal Portable Grill (22-SC01C-61)

Primary Cooking Surface	24" x 18" (432 sq. in.)
Warming Rack Surface	24" x 12" (288 sq. in.)





**Charcoal Patio Post Mount Grill** *(shown)*

**22-SC01C-P6**

Primary Cooking Surface	24" x 18" (432 sq. in.)
Warming Rack Surface	24" x 12" (288 sq. in.)



**Charcoal In-Ground Post Mount Grill**

**22-SC01C-G6**

Primary Cooking Surface	24" x 18" (432 sq. in.)
Warming Rack Surface	24" x 12" (288 sq. in.)

**31" Firemaster Drop-In Grill** **(3324\* shown)**

Cooking Surface	30" x 18" (540 sq. in.)
Cut-out Dimensions	31¼"w x 21¼"d x 12"h



**24" Firemaster Drop-In Grill** **(3329\*)**

Cooking Surface	23" x 16" (368 sq. in.)
Cut-out Dimensions	24¼"w x 19¼"d x 12"h

*Designed to drop into the top of your island.*

*Cooking grids must be ordered separately.*

**32" Lift-A-Fire Built-In Grill** **(3334\* shown)**

Cooking Surface	30" x 18" (540 sq. in.)
Cut-out Dimensions	32¼"w x 19¾"d x 12"h



**24" Lift-A-Fire Built-In Grill** **(3339\*)**

Cooking Surface	23" x 16" (368 sq. in.)
Cut-out Dimensions	24¾"w x 17¾"d x 12"h

*Cooking grids must be ordered separately.*



**Adjustable Charcoal Pan**

All charcoal grills feature a crank handle that allows you to adjust the height of the charcoal pan.



**Integrated Warming Rack**

Movable warming rack that adds a second level for optimum smoking performance. Stays horizontal for dual level smoking.

*\*Cooking grids and ovens (if desired) for Firemaster & Lift-A-Fire Slide-In must be ordered separately.*



## SIDE COOKERS

Power Burners, Side Burners, and Searing Stations

Fire Magic® side burners are designed as companion side cookers. All side burners feature a matching face for either Echelon Diamond or Aurora Grills. Featuring a contoured face, back-lit control knobs, hot-surface ignition, and a power switch. All Echelon accessories plug in to the Echelon Diamond Grill transformer for power and Aurora accessories plug into the Aurora transformer.

## Power Burners Feature Highlights

- Outstanding side cooker provides versatility in cooking.
- Up to 60,000 BTU's of cooking power, knob on left for inner burner has a range of 3,000-15,000 BTU's. Larger knob on right for outer burner has a maximum of 45,000 BTU's.
- Back-lit control knobs for added aesthetics and visibility.
- The **10" diameter, Heat Concentrating Flame Collimator** focuses heat in the center 25% of unit (for wok cooking, turkey frying or any other dish needing up to 190 BTU/sq. in. of heat).
- Power switch for easy operation.
- Power Burner Plugs in to the Echelon Diamond or Aurora Grill transformer for power.
- Also available in a battery operated version.



### Echelon Power Burner

Model #: **19-4B2N-0** (w/Porcelain Grid shown)

Burners	60,000 BTU's
Cut-out	19"w x 18¾"d x 12"h

The Echelon Power Burner is the largest, most powerful side cooker available and provides the high heat that's perfect for wok cooking or frying a turkey! Offering a range of 3,000 to 60,000 BTU's. Available with porcelain cast iron or stainless steel grids.



### Aurora Power Burner

Model #: **19-SLB1N-0** (w/Stainless Grid shown)

Burners	60,000 BTU's
Cut-out	19"w x 18¾"d x 12"h

The Aurora Power Burner is the largest, most powerful side cooker available. It provides a range of BTU's from 3,000 to 60,000. Available with porcelain cast iron or stainless steel grids.

Fire Magic® Power Burners include removable stainless steel lid and are available in Natural Gas or Propane.

# POWER BURNERS



### 10" Flame Collimator

The 10" dia. Heat Concentrating Flame Collimator focuses heat in the center 25% of unit (for wok cooking, turkey frying or any other dish needing up to 190 BTU/sq. in. of heat).

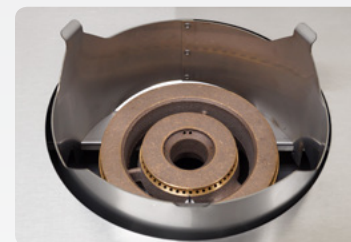

### Double Cast Brass Burner

Up to 60,000 BTU's of cooking power. Inner burner has a range of 3,000-15,000 BTU's, larger outer burner has a maximum of 45,000 BTU's.



### S.S. Griddle Adapter (#3683)

New Griddle Adapter allows you to use **both sizes** of Stainless Steel Griddles on your Fire Magic® Power Burner. (sold separately)

## Side Burners

### Echelon Double Side Burner

Model #: **32814**

Burners 30,000 BTU's (15,000 x 2)

Cut-out 11½" w x 22¾" d x 12" h

Enjoy precise flame control on each burner to prepare side dishes and sauces for your meal (Two [2] 15,000 BTU's burners). Available with porcelain cast or stainless steel grids.



### Echelon Single Side Burner

Model #: **32794-1**

Burner 15,000 BTU's

Cut-out 11½" w x 14" d x 12" h

The Echelon Single Side Burner features a 15,000 BTU's burner, precise flame control valve, and stainless steel cover. Available with porcelain cast grid.



### Aurora Double Side Burner

Model #: **3281L** (with Stainless Grid shown)

Burners 30,000 BTU's (15,000 x 2)

Cut-out 11½" w x 22¾" d x 12" h

The Double side burner offers precise flame control on each burner to prepare side dishes and sauces for your meal (Two [2] 15,000 BTU's burners). Available with porcelain cast or stainless steel grids.



### Aurora Single Side Burner

Model #: **3279L-1** (with Stainless Grid shown)

Burner 15,000 BTU's

Cut-out 11½" w x 14" d x 12" h

Features of this single side burner include a 15,000 BTU's burner, and precise flame control valve. Available with porcelain cast grid.



### Drop-In Side Burner

Model #: **3280**

Burner 15,000 BTU's

Cut-out 8¾" w x 14¼" d

Drops into the top of island. Features include 15,000 BTU's sealed burner, precise flame control valve, and stainless steel cover.



## Searing Stations

### Echelon Double Searing Station

Model #: **32884-1**

Burners	32,000 BTU's
Cut-out	19" w x 18¾" d x 12" h

With the Echelon Double Searing Station, prepare restaurant-quality steaks. When steaks are flash-cooked up to 1200° using infrared technology plus Diamond Sear cooking grids, juices are locked in and meats are tender and full of flavor.



### Echelon Searing Station

Model #: **32874-1**

Burner	24,000 BTU's
Cut-out	14" w x 22¾" d x 12" h

Sear favorites such as ahi tuna and marbled fillet mignon to perfection with 24,000 BTU's and up to 1000° of infrared heat. Perfect for an amazing seared steak. Includes the new Diamond Sear cooking grids.



### Aurora Double Searing Station

Model #: **3288L-1**

Burners	32,000 BTU's
Cut-out	19" w x 18¾" d x 12" h

With the Aurora Double Searing Station steaks are flash-cooked at 1200°, juices are locked in and meats are tender and full of flavor. With 32,000 BTU's of infrared heat and Diamond Sear cooking grids, the double searing station is a welcome cooking companion to your Fire Magic® grill.



### Aurora Searing Station

Model #: **3287L-1**

Burner	24,000 BTU's
Cut-out	14" w x 22¾" d x 12" h

This single searing station flash cooks up to 24,000 BTU's and up to 1000° of infrared heat locking in juices for tender meat and full flavor upon Diamond Sear cooking grids. Perfect for an amazing seared steak.



All Fire Magic® Searing Stations include stainless steel lid.





# REFRIGERATION PRODUCTS and REFRESHMENT CENTERS



## Outdoor Rated Refrigerator & Kegerator

### Outdoor Rated Refrigerator

Model w/right door hinge: **3589-DR** (shown)

Model w/left door hinge: **3589-DL**

Cut-out Dimensions 24" w x 27" d x 35" h

- 5.1 cubic feet of storage
- Internal digital thermometer
- Adjustable shelves
- LED internal light
- Lock and key
- Fire Magic® style handle
- Extra storage space available in the door
- UL listed for outdoor use



### Outdoor Rated Kegerator

Model w/right door hinge: **3594-DR**

Model w/left door hinge: **3594-DL** (shown)

Cut-out Dimensions 24" w x 27" d x 35" h

- Double tap kegerator
- Internal digital thermometer
- Closed door assist with lock and key system ensures your beverages will stay cold and secure
- Can accommodate a full, half, quarter or one-sixth sized kegs
- Metal shelves included to convert to a full refrigerator when not storing a keg
- UL listed for outdoor use



## REFRIGERATION PRODUCTS



### Lock and Key

Lock and key to ensure beverages will stay cold and secure.



### Digital Thermometer

Internal digital thermometer to maintain proper temperature for your beverages.



Kegerator accommodates a full, half, quarter or one-sixth sized kegs.

# REFRIGERATION PRODUCTS



## Refrigerators & Ice Maker

### Premium Refrigerator

Model w/right door hinge: **3598-DR** (shown)

Model w/left door hinge: **3598-DL**

Cut-out Dimensions  $20''\text{w} \times 21\frac{3}{4}''\text{d} \times 34\frac{1}{8}''\text{h}$

4.0 cubic feet of storage space. Custom-designed door is fabricated with a heavy-duty handle and square edges to match doors, drawers, and other accessories. Handy lock keeps contents safe. When used outdoors, it must be installed in an enclosure.



### Refrigerator

Model #: **3598**

Cut-out Dimensions  $20''\text{w} \times 21\frac{3}{4}''\text{d} \times 34\frac{1}{8}''\text{h}$

Interior light and security lock and key. Reversible door hinge. When used outdoors, it must be installed in an enclosure.



### High Capacity Ice Maker

Model #: **3597**

Cut-out Dimensions  $15\frac{1}{4}''\text{w} \times 25\frac{1}{4}''\text{d} \times 34''\text{h}$

Outdoor rated ice maker produces 63lbs of ice in a 24 hr. period. Capable of storing up to 27lbs of individual clear ice cubes. UL listed for outdoor use. Continuously produces ice on demand as ice used. Suitable for outdoor or indoor applications. Reversible door features horizontal handle that doubles as a Towel Bar.





### Refreshment Center

Model #: **3596A**

Cut-out Dimensions 25" w x 25" d x 12" h

Insulated walls, bottom drain, in-front shelving, attached bottle opener, included drain kit, Echelon styled face and hinged removable lid.



### Drop-In Refreshment Center

Model #: **33596**

Cut-out Dimensions 25" w x 23 $\frac{3}{8}$ " d x 12 $\frac{3}{4}$ " h

Use like an ice cooler in your grill island to keep soda, beer or other beverages cold and frosty. Includes handy drain kit and hinged removable insulated lid.



### Bar Caddy

Model #: **1D-S0**

Cut-out Dimensions 14 $\frac{1}{4}$ " w x 22 $\frac{3}{4}$ " d x 12" h

Bar Caddy comes equipped with a towel bar, bottle opener, sliding storage drawer, two stainless steel bottle sleeves and an installation hanger. Available with the optional steam warming accessory.



## REFRESHMENT CENTERS



Bottle Opener



# ISLAND SYSTEMS

## GLASS FIBER REINFORCED CONCRETE ISLAND SYSTEMS

Constructed from durable Glass Fiber Reinforced Concrete (GFRC) and easily assembled on site, these Island Systems are designed specifically for Fire Magic® equipment and make a stunning statement. Café Blanco island bases with contrasting polished GFRC Smoke counter tops provide a handsome concrete look.



## DL660 L-Shape "Reclaimed Wood" Island Systems

L-Shape islands feature a "Reclaimed Wood" style French Barrel Oak (FO) or new weathered look Silver Pine (SP) base finishes with Polished Black Lava counter tops. The elevated corner section is perfect for seating and has a hole for a locally sourced umbrella. Showcasing an E660i Echelon grill, there are three choices of accessories for the return side (Kegerator, Refrigerator or Medium Pantry Drawer). All versions include an additional storage door access on the outside and a metal shelf behind the double doors to keep items off the ground.

Dimensions: 116" w x 84" d x 42½" h

MODEL #	RETURN SIDE ACCESSORY	BASE COLOR
<b>DL660-FOK-116BA</b>	Kegerator (shown)	French Barrel Oak (FO)
<b>DL660-FOR-116BA</b>	Refrigerator	
<b>DL660-FOD-116BA</b>	Medium Pantry	
<b>DL660-SPK-116BA</b>	Kegerator	Silver Pine (SP)
<b>DL660-SPR-116BA</b>	Refrigerator	
<b>DL660-SPD-116BA</b>	Medium Pantry	

### Required Components (sold separately):

- E660i - Built-in grill
- 32814 - Double side burner
- 53802SC - Double Drawer
- 53934SC - Double Door
- 53920SC-R (-L) - Single access door
- 53820SC-TL (-TR) - Single access door w/tank tray & louvers [or 53920SC-R (-L) - Single access door or 53820TSC - Trash Cabinet]

### Plus your choice of:

- 3594-DR (-DL) - Outdoor Kegerator
- 3589-DR (-DL) - Outdoor Refrigerator
- 54018S - Medium Pantry Drawer



Additional Access Door on the outside.

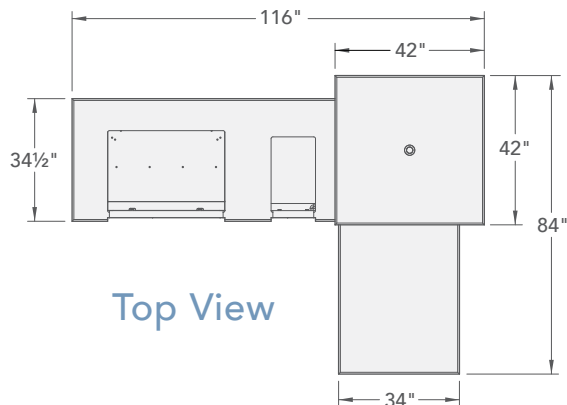



**DC790 Island w/Refrigerator**  
Model #: **DC790-CBR-108SM**



**DC430 Island w/Refrigerator**  
Model #: **DC430-CBR-75SM**



**DC790 Island w/Double Drawer**  
Model #: **DC790-CBD-108SM**



**DC430 Island w/Double Drawer**  
Model #: **DC430-CBD-75SM**

### DC790 GFRC Island Systems

Dimensions: 107½" w x 34¾" d x 36" h

Required Components (sold separately)

- E790i or A790i - Built-In Grill
- 32814 or 3281L - Built-In Double Side Burner
- 3598-DR (-DL) or 3590-DR (-DL) - Refrigerator (for DC790-CBR-108SM model)
- 53802SC or 33802 - Double Drawer (for DC790-CBD-108SM model)
- 53938SC or 33938S - Reduced Height Dbl. Access Doors
- 53920SC-R (-L) or 33920-SR (-SL) - Vertical Single Access Door

### DC430 GFRC Island Systems

Dimensions: 76¼" w x 34¾" d x 36" h

Required Components (sold separately)

- A430i or C430i - Built-In Grill
- 3598-DR (-DL) or 3590-DR (-DL) - Refrigerator (for DC430-CBR-75SM model)
- 53802SC or 33802 - Double Drawer (for DC430-CBD-75SM model)
- 53914SC-R (-L) or 33914-SR (-SL) - Horizontal Single Access Door
- 53920SC-R (-L) or 33920-SR (-SL) - Vertical Single Access Door

# PREMIUM ACCESSORIES



## Premium Accessories

### Protective Grill Covers

Model #: **Various "F" Styles**

Custom fitted to Fire Magic® grills and accessories, these black covers are manufactured with a PVC exterior and Polyester "breathable" interior providing excellent protection to any Fire Magic® product.



### Five-Piece Tool Set

Model #: **3575B**

Packed in a handsome zippered nylon logo case, our 5-piece tool set includes stainless steel tongs, meat fork, silicone-tipped basting brush, slotted flat spatula with serrated edges and built-in bottle opener and a two-sided grill brush.



### Charcoal/Smoker Basket

Model #: **3564-1** (Fits 18" deep Aurora grills)

Model #: **3564-2**  
(Fits All Echelon grills & 22" deep Aurora grills)

Cooking with wood chunks or charcoal is easier than ever. Basket sits on top of the burner, gas burners ignite the chunks or coals. Includes smoker cover and bottom tray that catches ashes for easy clean-up. Includes easy to use safety cover lifter.



### Warming Rack Extender

Model #: **3682A**

Dimensions: 14" w x 7" d

Add 100 square inches of indirect grilling (or warming) space to 22" deep Echelon and Aurora Grills with the new Warming Rack Extender, simply hook on the rear edge of the existing warming rack.



### Stainless Steel Griddle

Model #: **3515** (Fits 18" deep Fire Magic® grills)

Model #: **3516** (Fits 22" deep Fire Magic® grills)

This unique grilling accessory heats up fast and allows you to cook all your meals in your outdoor kitchen.



### Power Burner/DbL. Searing Station Griddle Adapter

Model #: **3683** (For 3515 & 3516 S.S. Griddles)

Griddle Adapter allows use of both sizes of Fire Magic® Stainless Steel Griddles on your Fire Magic® Power Burner or Double Searing Station.

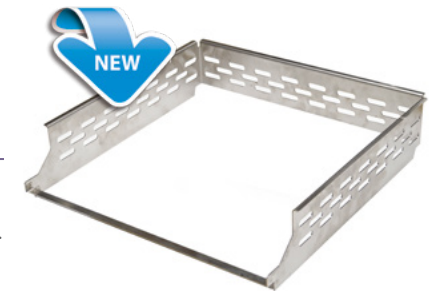

### Cast Iron Griddle

Model #: **3512A** (Fits 18" deep Fire Magic® grills)

Model #: **3513A**  
(Fits 22" deep Fire Magic® grills and DbL. Side Burners)

Griddle available for the Fire Magic® double side burner as well as the Echelon and Aurora grills. Perfect for breakfast, grilled vegetables or fajitas.



### Grilling Tray

Model #: **3567**

Dimensions 13½" w x 14¾" d

Expand your cooking horizons with the Fire Magic® Grilling Tray. The durable black porcelain finish, angled sides and easy access low profile front makes cooking smaller food on your Fire Magic® grill a snap!



## Premium Accessories

### Built-In Beverage Center

Model w/Echelon Style Face: **1D-SSD** (shown)

Model w/Aurora Style Face: **1D-SSA**

Cut-out: 36¾" w x 23½" d x 12" h

Features top storage shelf with rail, faucet with sink and drain, removable bamboo cutting board, storage drawer, wine glass holder, halogen lights, covered heavy-duty blender, insulated ice drawer, and 2 condiment holders.



### Blender w/Stainless Steel Hood

Model #: **3284A**

Cut-out: 8¾" w x 14¼" d

Fire Magic's® Blender is the perfect companion for any outdoor kitchen, bar caddy or beverage center. The attractive and sturdy stainless steel cover protects the 675-watt motor from the elements.



### Paper Towel Holder

Model #: **53812**

Cut-out: 12" w x 8" d x 9¼" h

Accepts and protects regular or jumbo rolls.

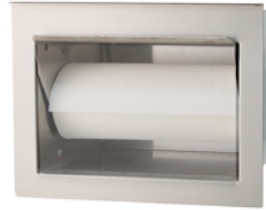

### Sink & Faucet

Model #: **3587 & 3588**

Cut-out: 14" w x 14" d x 17" h

Adds convenience and functionality to your outdoor kitchen. Purchase separately or together. Sink measures 15" x 15" x 6" and requires a 17" clearance underneath.



### Cut & Clean Combo

Model #: **53816**

Cut-out: 9½" w x 4½" d x 15" h

Allows you to slice and dice on a Fire Magic® bamboo cutting board, then sweep debris right into the Fire Magic® trash container or basic trash can via a deep stainless steel trash chute. Chute measures 14¾". Stainless steel lid included.



### Trash Container

Model #: **53825-T**

Cut-out: 12¾" w x 20" d x 24" h

Constructed of stainless steel with a hands-free foot lever, the door easily slides open to reveal a 10.5 gallon trash can. Fully enclosed. Great for use under the Cut & Clean Combo.



### Wok

Model #: **3572**

Hard-anodized stick-resistant lined interior surface measures 14" in diameter.



### Motorized Hood Kit

Model #: **3422-E2**

Motorized Hood Kit is compatible with **All** current Echelon Grills.

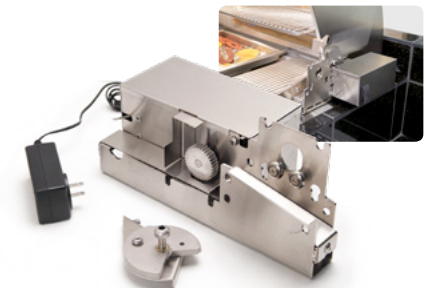

## Premium Accessories

### Gas Timer Box

Model #: **5520-11T** (1-hour timer)

Model #: **5520-13T** (3-hour timer)

Cut-out: 6½" w x 6½" h

Clean and attractive 304 stainless steel connection box with safety timer (1-hour or 3-hour). Matches Premium Flush (5-series) doors and drawers. Overall dimensions with flange: 7¾" w x 2½" d x 7¾" h.



### Gas Connection Box

Model #: **5520-01T**

Gas connection box with quick disconnect and 1-hour timer for safety. Clean and attractive 304 stainless steel box.



### Safety Timer

Model #: **3090** (3-hour timer)

Model #: **3092B** (1-hour timer)

Fire Magic's® 3-hour, and 1-hour, Safety Timers offers additional safety and automatically shuts off gas flow at pre-set times. Easy to install. Great for apartment and condominium use.



### Grill Light

Model #: **3574**

This halogen 10 watt bulb makes evening grilling easy. When using the light on a grill without backburner, a light bracket must be ordered. Aurora Light Bracket: 3600-43, Legacy Light Bracket: 3600-18-SP.



### Turkey Fryer Kit

Model #: **3570**

You'll be amazed at how tender a deep-fried turkey can be. Kit includes pot, inner basket with sturdy handle and thermometer probe. Great as a crab or corn pot.



### Bamboo Cutting Board

Model #: **3582-1**

Dimensions: 14" w x 12" d

This durable and functional Bamboo Cutting Board is perfect for preparing meats and vegetables for grilling.



### Rotisserie Basket

Model #: **3618**

A versatile, stainless steel basket for skewers, burgers, ribs or fish.

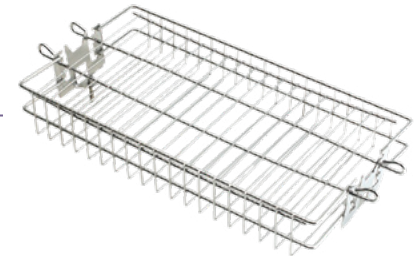

### Turkey Holder

Model #: **3615E**

This sturdy holder is also perfect for beef, pork and lamb roasts.

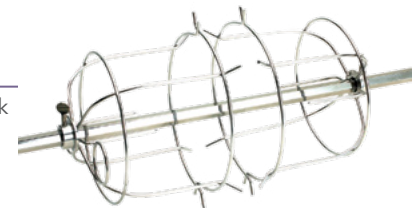

### Chicken Holder

Model #: **3617E**

Enjoy a golden, succulent chicken the quick and easy way!



## Insulating Liner & Vent Hood

### Insulating Liner

The Insulating Liner facilitates installation of built-in Fire Magic® grills into wood, composite or other combustible enclosures when used with non-combustible counter tops. Sizes are available for all Echelon, Aurora and Legacy Deluxe grills as well as Power Burners & Searing Stations.

### Feature Highlights:

- Hanger for easy installation
- Reduced clearance
- No additional support beneath the liner required
- 304 stainless steel construction
- Pre-assembled in box

#### Available Insulating Liner Models

- 3185-51 Used with Echelon E1060i Built-In Grills
- 3186-51 Used with Echelon E790i & Aurora A790i Built-In Grills
- 3176-51 Used with Echelon E660i & Aurora A660i Built-In Grills
- 23150-51 Used with Aurora A540i & Choice C540i Built-In Grills
- 23125-51 Used with Aurora A530i Built-In Grills
- 23130-51 Used with Aurora A430i & Choice C430i Built-In Grills
- 3100-51 Deluxe Built-In Grill
- 3278-51 Power Burner & Double Searing Station
- 3287-51 Searing Station

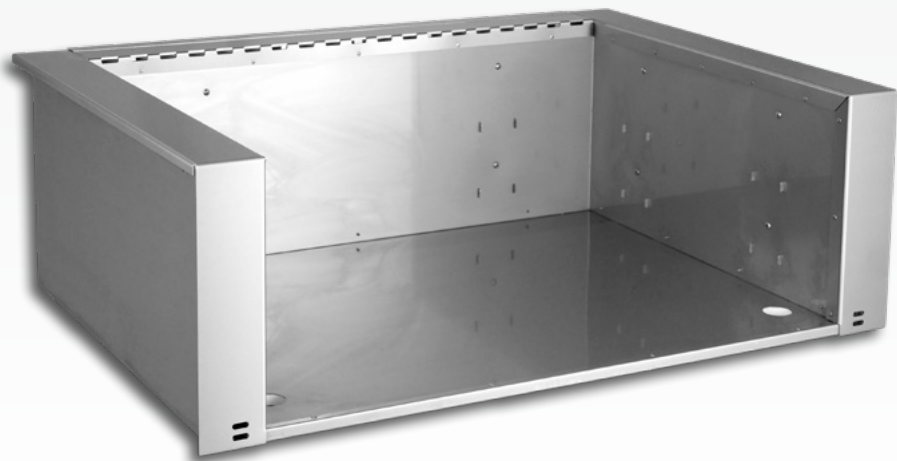

### Vent Hood



The Fire Magic® Outdoor Grill Vent Hood quickly exhausts excess smoke from covered patios. From its efficient dual fans (1200 CFM total) to the configuration of the hood itself, the Grill Vent Hood is created specifically for your outdoor grilling environment. With powerful halogen under-mount lamps, your grilling area can be illuminated for evening cooking.

#### Vent Hood Specifications

Electrical requirements	120 volts, 60 hertz, 20 amp; GFI outlet.
Blowers (2)	1,200 CFM (600 CFM Each)
Power Consumption	1,010 watts

### Feature Highlights:

- Powerful dual blowers (1200 CFM total) specifically designed and engineered to quickly extract smoke, grease, and odors from the front and rear of the hood
- High quality brushed 304 stainless steel construction with seamless polished edges
- Dual halogen under-mount lamps provide generous light for evening grilling
- Thermal safety sensor automatically activates fans when temperature reaches 140° F
- On demand control knobs offer a high and low setting for lights and fan
- Anodized aluminum filters remove easily and are dishwasher safe
- Available in 36", 42", 48", and 60" widths
- All units are 30" deep
- Vent piping not included

#### Available Models

- 36-VH-6 36" Vent Hood
- 42-VH-6 42" Vent Hood
- 48-VH-6 48" Vent Hood
- 60-VH-6 60" Vent Hood





# DOORS & DRAWERS

*All cut-out dimensions, images and diagrams are for reference purposes only. Fire Magic® reserves the right to change the information contained in this catalog without notice. Please refer to your instruction manual for the most up to date information specific to your product.*

## FLUSH MOUNTED

### Doors & Drawers (5 Series)



Featuring heavy-duty handles with cast stainless steel mounts, these 304 stainless steel doors and drawers are designed to close flush with the frame using a strong magnetic latch. Flush Mounted Doors and Drawers are filled with polyurethane foam for insulation and a solid feel. A continuous rain guard protects from water getting into your custom enclosure.



In addition, most 5-Series doors and drawers now have a soft-close feature for smooth

transition while opening and closing. Available in a variation of door and drawer configurations and sizes. With so many options there is a combination available to meet any outdoor kitchen storage need.

Pantry sealed and gasketed Door/Drawer combos feature self-closing, magnetic seal drawers.

## Flush Mounted Doors & Drawers (5 Series)

### Vertical Single Access Doors

Model #	Hinge	Cut-out
• <b>53920SC-R</b>	Right	21" h x 14½" w
• <b>53920SC-L</b>	Left	21" h x 14½" w
• <b>53924SC-R</b>	Right	25" h x 17½" w
• <b>53924SC-L</b>	Left	25" h x 17½" w



Model Shown: 53920SC-L

### Horizontal Single Access Doors

Model #	Hinge	Cut-out
• <b>53914SC-R</b>	Right	15" h x 20½" w
• <b>53914SC-L</b>	Left	15" h x 20½" w
• <b>53917SC-R</b>	Right	18" h x 24½" w
• <b>53917SC-L</b>	Left	18" h x 24½" w



Model Shown: 53914SC-R

### Double Access Doors

Model #	Cut-out
• <b>53934SC</b>	15" h x 30" w
• <b>53930SC</b>	21" h x 30" w
• <b>53938SC</b>	16" h x 39" w



Model Shown: 53930SC



### Large Pantry Door/Drawer Combo

Model #: **54020S**  
Cut-out: 33½" h x 20" w x 26" d



### Medium Pantry Door/Drawer Combo

Model #: **54018S**  
Cut-out: 25" h x 17½" w x 26" d

Flush Mounted Doors & Drawers (5 Series)



Door/Drawer Combo (w/platter storage)

Model #: **53816SC**  
Cut-out: 18½" h x 36½" w x 26" d



Door/Drawer Combo

Model #: **53810SC**  
Cut-out: 18½" h x 30" w x 26" d



Double Doors w/Dual Drawers

Model #: **53930SC-22**  
Cut-out: 21" h x 30½" w x 20½" d



Double Doors with Trash Tray & Dual Drawers

Model #: **53930SC-12** (w/o Louvers shown)  
Model #: **53930SC-12T** (with Louvers)  
Cut-out: 21" h x 30½" w x 20½" d



Electric Warming Drawer†

Model #: **53830-SW**  
Cut-out: 14½" h x 32¼" w x 22" d



Masonry Drawer

Model #: **53830SC**  
Cut-out: 14½" h x 32¼" w x 22" d



Single Door w/Dual Drawers

Model #: **53820SC-R** or **L**  
Cut-out: 21" h x 14½" w x 20½" d



Door with Tank Tray & Louvers

Model #: **53820SC-TL** or **TR**  
Cut-out: 21" h x 14½" w x 20½" d



Triple Drawer

Model #: **53803SC**  
Cut-out: 26¼" h x 14½" w x 20½" d



Double Drawer

Model #: **53802SC**  
Cut-out: 16" h x 14½" w x 20½" d



Single Drawer

Model #: **53801SC**  
Cut-out: 5¼" h x 14½" w x 20½" d



Trash Cabinet

Model #: **53820TSC**  
Cut-out: 21" h x 14½" w x 19¼" d  
Trash Cabinet includes two 3.25 gallon trash bins (1 black, 1 blue).

†Buffet Warming Accessory available. Model No: 23830-SW-CD

## SELECT

### Doors & Drawers (3 Series)



These 304 stainless steel doors and drawers feature outside mounting, double wall and square edge construction, a slim tubular stainless steel handle and heavy-duty magnetic latch. A continuous rain guard protects from water getting into your custom enclosure. Available in a large variety of door and drawer configurations and styles.

### Select Doors & Drawers (3 Series)

#### Vertical Single Access Doors

Model #	Hinge	Cut-out
• <b>33920-SR</b>	Right	21" h x 14½" w
• <b>33920-SL</b>	Left	21" h x 14½" w
• <b>33924-SR</b>	Right	25" h x 17½" w
• <b>33924-SL</b>	Left	25" h x 17½" w



Model Shown: 33920-SR



Model Shown: 33924-SR

#### Horizontal Single Access Doors

Model #	Hinge	Cut-out
• <b>33914-SR</b>	Right	15" h x 20½" w
• <b>33914-SL</b>	Left	15" h x 20½" w
• <b>33917-SR</b>	Right	18" h x 24½" w
• <b>33917-SL</b>	Left	18" h x 24½" w



Model Shown: 33914-SR



Model Shown: 33917-SR

#### Double Access Doors

Model #	Cut-out
• <b>33930S</b>	21" h x 30" w
• <b>33938S</b>	16" h x 39" w



Model Shown: 33930S



Model Shown: 33938S

Select Doors & Drawers (3 Series)



**Door/Drawer Combo** (w/platter storage)

Model #: **33816S**  
Cut-out: 18½" h x 36½" w x 26" d



**Door/Drawer Combo**

Model #: **33810S**  
Cut-out: 18½" h x 30" w x 26" d



**Double Doors w/Dual Drawers**

Model #: **33930S-22**  
Cut-out: 21" h x 30½" w x 20½" d



**Double Doors with Tank Tray & Dual Drawers**

Model #: **33930S-12T** (w/Louvers shown)  
Model #: **33930S-12** (w/o Louvers)  
Cut-out: 21" h x 30½" w x 20½" d



**Electric Warming Drawer**<sup>†</sup>

Model #: **33830-SW**  
Cut-out: 13" h x 31" w x 20½" d



**Masonry Drawer**

Model #: **33830-S**  
Cut-out: 13" h x 31" w x 20½" d



**Single Door w/Dual Drawers**

Model #: **33820-SR** or **SL**  
Cut-out: 21" h x 14½" w x 20½" d



**Door with Tank Tray & Louvers**

Model #: **33820-TSL** or **TSR**  
Cut-out: 21" h x 14½" w x 20½" d



**Triple Drawer**

Model #: **33803**  
Cut-out: 26¼" h x 14½" w x 20½" d



**Double Drawer**

Model #: **33802**  
Cut-out: 16" h x 14½" w x 20½" d



**Single Drawer**

Model #: **33801**  
Cut-out: 5¼" h x 14½" w x 20½" d



**Single Access Door w/Louvers**

Model #: **33920-1-SL** or **SR**  
Cut-out: 21" h x 14½" w

<sup>†</sup>Buffet Warming Accessory available. Model No: 23830-SW-CD

# LEGACY

## Doors & Drawers (2 Series)



Outside mounted with angled edges, the Legacy Doors and Drawers are made of 304 stainless steel and feature a slam latch for secure closure.

The Legacy doors and drawers are the most economical for builders and homeowners alike.

### Legacy Doors & Drawers (2 Series)

#### Vertical Single Access Doors

Model #	Hinge	Cut-out
• <b>23918-S</b>	Reversible	18½" h x 12½" w
• <b>23920-S</b>	Reversible	20½" h x 14½" w
• <b>23924-S</b>	Reversible	24½" h x 17½" w
• <b>23920-1-S*</b>	--	20½" h x 14½" w

\*Door includes louvers



Model Shown: 23920-S



#### Masonry Drawer

Model #: **23830-S**  
Cut-out: 13" h x 31" w x 20½" d

#### Horizontal Single Access Doors

Model #	Hinge	Cut-out
• <b>23912-S</b>	Reversible	12½" h x 18½" w
• <b>23914-S</b>	Reversible	14½" h x 20½" w
• <b>23917-S</b>	Reversible	17½" h x 24½" w



Model Shown: 23912-S



#### Single Door w/Dual Drawers

Model #: **23820-S**  
Cut-out: 20½" h x 14½" w x 20½" d

#### Double Access Doors

Model #: **23930-S**  
Cut-out: 20½" h x 30" w



#### Double Doors with Trash Tray & Dual Drawers

Model #: **23930S-12**  
Cut-out: 21" h x 30½" w x 20½" d



#### Door with Tank Tray & Louvers

Model #: **23920-1T-S**  
Cut-out: 20½" h x 14½" w x 20½" d



#### Louvered Stainless Steel Venting Panel

Model #: **5510-01**  
Cut-out: 5" h x 12¾" w  
Panel Size: 6" h x 14" w

## FIRE MAGIC® OUTDOOR GAS GRILL AND ACCESSORY WARRANTY HIGHLIGHTS\*

Crafted with pride in the USA and constructed entirely of 304 stainless steel, Fire Magic® has been manufacturing the finest outdoor grills and accessories you can buy for over 80 years. Our warranty coverage reflects the quality materials and craftsmanship found in all Fire Magic® grills.

When investing in a grill, consider the assurance provided by the Fire Magic® warranty:

- Fire Magic® pays for first year warranty labor allowance
- Fire Magic® pays for shipping warranted replacement parts
- Fire Magic® pays for shipping warranted defective parts back to the factory
- Fire Magic's® qualified technical service representatives are available 10 hours a day, 5 days a week to assist with questions, installation and service

You will find the Fire Magic® warranty to be the best and most comprehensive in the industry.

### LIFETIME WARRANTY

Cast stainless steel burners, Diamond Sear and rod stainless steel cooking grids and stainless steel housings.

### TWENTY (20) YEAR WARRANTY

Choice stainless steel u-shaped burners.

### FIFTEEN (15) YEAR WARRANTY

Brass valves, inner liners, manifold assemblies, porcelain housings (including ovens and barbecue faces), and backburner assemblies (except ignition parts).

### TEN (10) YEAR WARRANTY

Electric grills, including stainless steel cooking grids and housings.

### FIVE (5) YEAR WARRANTY

Flavor grids, infrared burners in the grill, Charcoal stainless steel grills and Smokers (except for the charcoal pan, charcoal grid, wood pellet screen, thermometer and ash tray; which are warranted for one (1) year.)

### THREE (3) YEAR WARRANTY

Side burners and all other Fire Magic® grill components (except ignition and electronic parts).

### ONE (1) YEAR WARRANTY

Ignition systems (except batteries), electronic components (including lights & thermometers) and grill accessories.

***This warranty applies to the original purchaser with proof of purchase and to single family residential use only.***

For additional information regarding this warranty, or about multi-user warranty, or to place a warranty claim contact your authorized Fire Magic® dealer.

*\*See full warranty for complete details.*

*All cut-out dimensions, images and diagrams are for reference purposes only. Fire Magic® reserves the right to change the information contained in this catalog without notice. Please refer to your instruction manual for the most up to date information specific to your product.*



GRILLING WITH

*Anna Rossi*

Visit [firemagicgrills.com/grilling-with-anna/](https://firemagicgrills.com/grilling-with-anna/)  
for exclusive delicious recipes and cooking  
tips from Master Chef's Anna Rossi.

# FIREMAGIC<sup>®</sup>

BUILT WITH PASSION. OWNED WITH PRIDE.

14724 East Proctor Ave., City of Industry, CA 91746

[www.firemagicgrills.com](https://www.firemagicgrills.com)

